



WE MAKE IT **EASY**

Platinum

OPTIONS
BOOK

Let us customize it *Just for You!*

No two families are the same. No two people are the same. And we believe no two homes should be the same. That's why we are so excited to customize your home just for you.

Let this book guide you through some of our available options. It will let you create your own unique home - exclusively for you. As a compliment to this book, request a copy of our Platinum Series Floor Plans book to review numerous plan ideas to use as they are or as a starting point to edit to your heart's content.

What's more impressive is that all this Luxury is Affordable! We have searched for the most comprehensive selection of value for money upgrade options. We understand that everyone has a schedule and a budget. Feeling overwhelmed? Ask about our Classic Series homes.

**So, happy reading. Take your time.
Building a new home isn't something you
do every day. Make sure you do it well.
Make it yours.**

Customized
TO MEET YOUR NEEDS









Contents

About Northstar	6
The Northstar Difference	9
Visit Us Online	13
The Manufacturing Process	15
Exterior Options	17
Interior Options	39
Comfort Options	128
Standard Specifications	131
Construction Details	134
Warranty Information	143

About

Northstar Systembuilt was founded in 1995 in Marshall, MN. Starting off as a **family-owned business**, Northstar was built up on good old-fashioned quality and personalized service. While the business has now grown to a thriving and **well-recognized manufacturer of modular homes**, these attributes have not been compromised. To facilitate further growth of Northstar, we relocated our manufacturing facility to **Redwood Falls, MN** in 2013 into a large modern factory. Since then, we have acquired another facility for production and have expanded both our onsite and offsite storage. We have completed an addition to our main production line, which was completed in 2022 as well as have also added a second production facility in Watertown, SD in June of 2022 to assist with the market demand for our product.



Our stringent quality control program assures you of a finely finished state-of-the-art building. With our tremendous buying power and consolidated ordering system, we are able to pass on huge savings to yourself, offering you a **quick, hassle-free, cost-effective** realization of your building ambitions.

We take every interest in your particular needs to enable us to tailor a solution that not only meets, but exceeds them. Our creativity and flexibility in design have made us the preferred supplier to many clients across the Midwest.

Northstar Systembuilt

OUR DEALERS

Northstar does not retail directly to the general public, but has an **exclusive dealer and builder network located throughout the Midwest** to the foothills of the Rockies. Our dealers have model home(s) on their lots for viewing, a selection center with the color options displayed in this brochure and much more! **Combining their experience and your vision will enable you to work together to create the home of your dreams!** Consult with the dealer or builder for pricing on an entire package - home, basement, garage, deck, etc.

Visit our website - www.northstarsb.com - or call us directly to be redirected to a dealer that will be best suited to serve your needs.

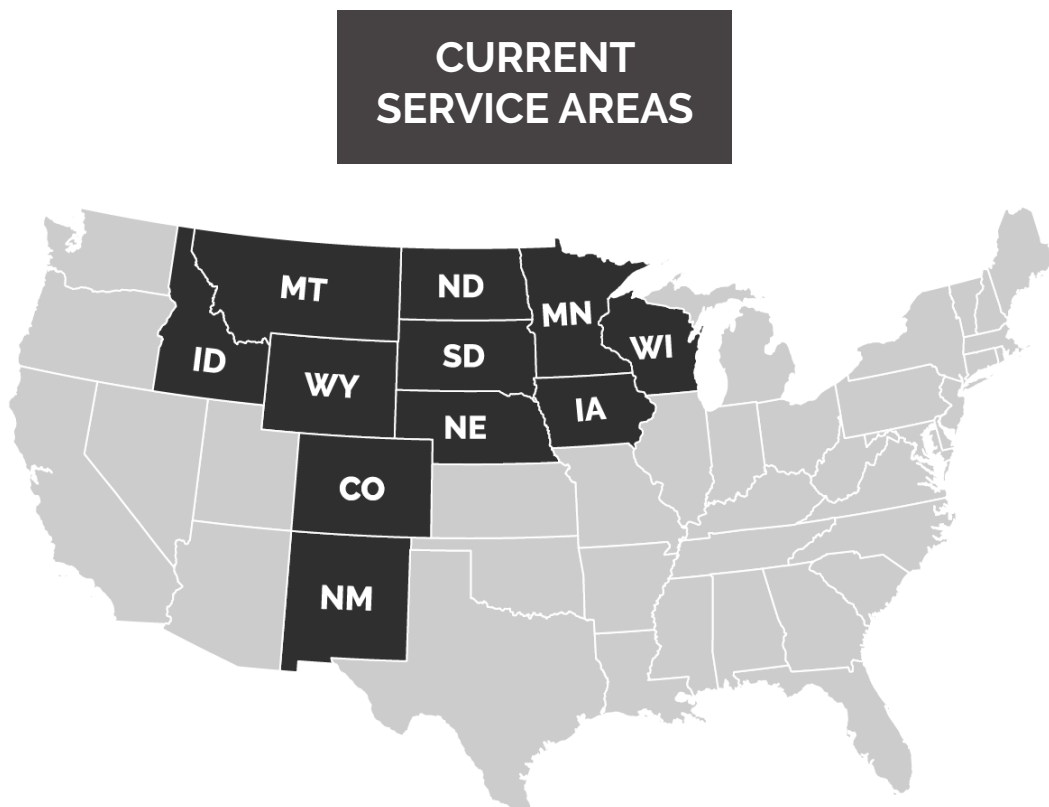

OUR TEAM

Northstar Systembuilt is a workplace where **humor and hard work go hand in hand**. Staff share the passion for the company through being included in business development and planning. Our core values attract staff that truly desire to make a difference.

Our team enjoys a well organized structure but are still given the latitude to operate autonomously without the burdens of a hierarchy – in plain English, we work together and we have fun!

FACILITIES, EXPERIENCE, & CULTURE

Clients choose us because they trust us. We've got the experience, the facilities, but most of all we're the sort of bunch they want to deal with.



Redwood Falls, MN Crew



Watertown, SD Crew

SUPERIOR CONSTRUCTION

- All electrical outlet boxes mounted to studs - **outlets remain intact and do not loosen over time**
- Insulated Rim Joists
- Batt insulation at energy heel of truss - **reduce ice dams and heat loss**



HAPPY CLIENTELE!

"It is too beautiful for words. I'm not kidding...I had a dream for this house, and it far exceeds anything I could have imagined. The craftsmanship overall is so gorgeous. Your recommendations and expertise were invaluable. I could not be happier with the look of the interior and the exterior. I know we had some bumps in the road along the way, but the end result was worth it and this is a project that everyone can be really proud of. All I had was an idea on paper and you guys brought it to life. I am eternally grateful."

TERRY R. - Northfield, MN

Quality PRODUCTS

Northstar's team of craftsmen have the desire to perform quality work, coupled with that desire is the **installation of quality products with great warranties and track records to create an exceptional, sustainable home - inside & out!**



Accessories

- Moen Faucets
- Better Home Products
- KwikSet Hardware

Quality Siding & Shingles

- GAF
- CertainTeed
- James Hardie
- DiamondKote
- LP SmartSide

Quality Cabinetry

- BayerBuilt Woodwork
- Timberline Bathroom Products

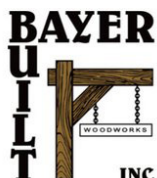



At Northstar, our goal is to build a home to suit you and your tastes no matter what your style. From timeless clawfoot tubs to contemporary free-standing baths, we've got the options that are sure to make you smile.



Lighting

- Interior & Exterior
- Fixtures, Fans

Flooring

- Shaw Carpet
- MSI Hardwood
- MSI Hybrid Rigid Core
- BeauFlor

Countertops

- Quartz
- Granite
- Laminate
- Cultured Marble
- Thinscape

Quality Appliances

- GE™, GE Profile™ & Cafe™ Kitchen Appliances
- AO Smith Water Heaters
- Champion Furnaces



AN ABUNDANCE OF PLANS TO BROWSE

Our **Find a Home** and **Floor Plans** tabs make it very easy for you to find plans! You can browse by Style, Series or even search for a specific number of bedrooms, etc. We even have an option for you to upload a napkin sketch!

ENDLESS OPTIONS & UPGRADES

All of our options & upgrades are showcased both in this **Platinum Series Options Book** and on our **easy-to-navigate, mobile-friendly website!**

It's your chance to design your home exactly how you've always dreamt it should be! Choose from our hundreds of options to customize your home or let us know what you have in mind and we'll prep for on-site installation of the finishes or fixtures of your choice.

Remember Luxury is Affordable!

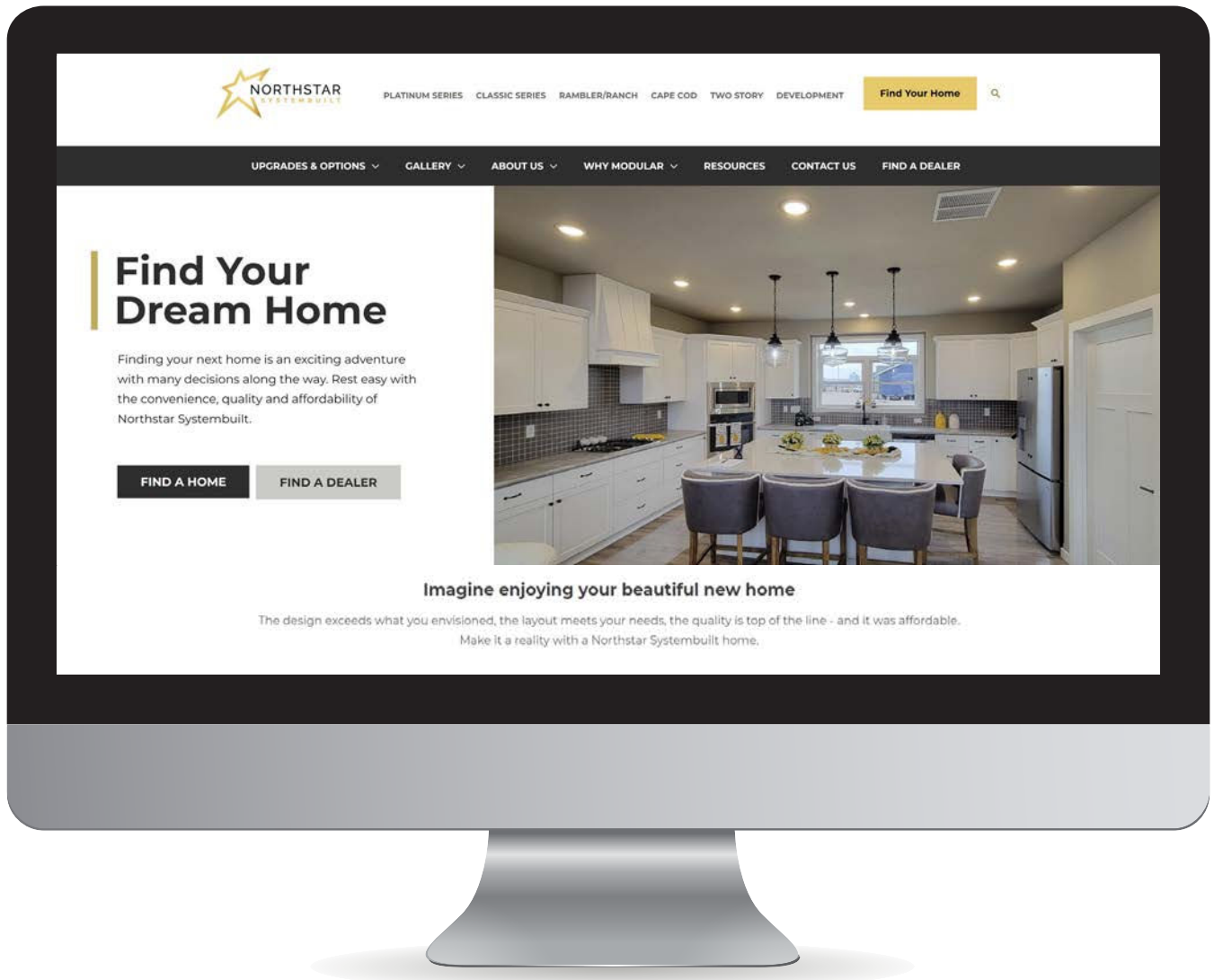

VISIT US *Online*

GALLERY & TOURS

Just as artists use talent to transform a blank canvas into a work of their own, our team at Northstar uses a combination of skill and passion to transform a floor plan drawing into **the home of your dreams.**



Virtual Tours



Exterior

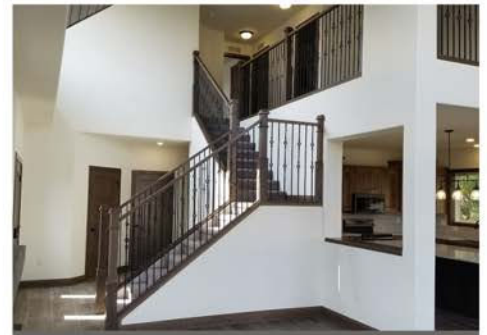

Interior



Construction



Transport & Setting



Videos

www.northstarsb.com



COME CHECK OUT OUR *Factory*

Northstar manufactures using a moving production line.
Every building moves through 9 stations within our factory.

Each station has the tools and materials required for the trades to
do their portion of the work before it moves on to the next station.

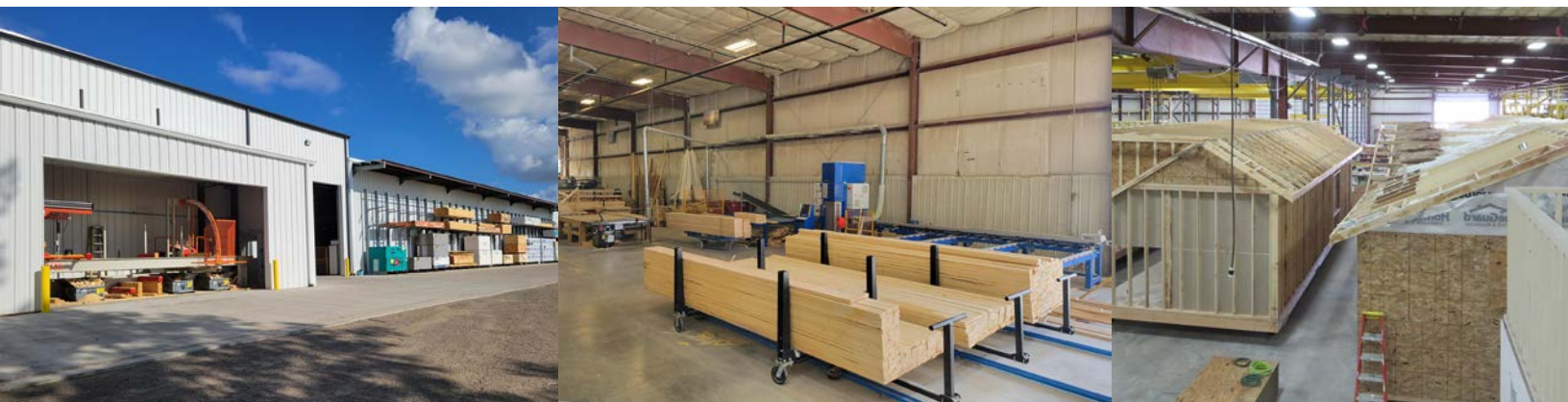

The Manufacturing Process

- | | | | |
|-----------|---|-----------|--|
| 01 | FLOOR FRAME ASSEMBLY,
DECKING & ROUGH PLUMBING | 02 | WALL FRAME ASSEMBLY |
| 03 | WALL SET | 04 | ROOF ASSEMBLY, ROOF SET
& ELECTRICAL |
| 05 | BACK INSULATE
& DRYWALL SET | 06 | TEXTURE, PAINT &
EXTERIOR SHEATHING |
| 07 | WINDOWS, SIDING
& SHINGLES | 08 | CABINETRY, DOORS, FINAL
PLUMBING & INTERIOR FIT-OUT |
| 09 | FINAL INSPECTION/TESTING | 10 | CLOSE-UP & SHIPPING PREP |

Schedule a factory tour to see it for yourself! It really is amazing - using jigs, cranes and state of the art equipment, we are able to build many houses simultaneously inside our factory! Our craftsmen are experts in the areas that they work in.

To Request a Factory Tour, Visit Us at:

www.northstarsb.com



SHINGLES



SOFFIT & FASCIA



SIDING



EXTERIOR OPTIONS



WINDOWS



EXTERIOR DOORS

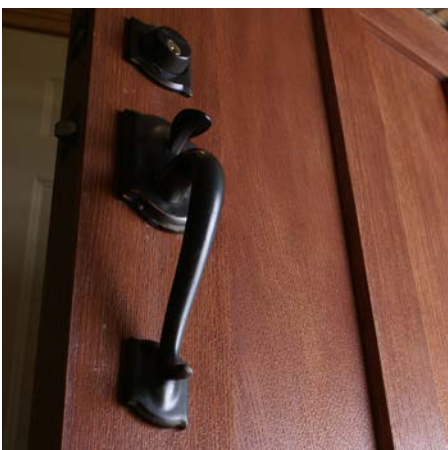

HARDWARE

Make your statement with the exterior of your home.

Just as artists use talent to transform a blank canvas into a work of their own, Northstar partners with each individual dealer **combining skill and passion to create the home of your dreams.** From various siding colors and styles, to stone feature walls, we can give your home eye-catching **curb appeal.**

EXTERIOR

Options

Shingles	18
Soffit & Fascia	19
Siding	20
Exterior Accents	26
Exterior Options	28
Windows	30
Exterior Doors	34
Exterior Door Hardware	36





SHINGLES

Fiberglass asphalt shingles with Lifetime limited transferable warranty from GAF or CertainTeed are available on all of our homes. (See manufacturer's website for warranty details)

STANDARD COLOR OPTIONS



Barkwood



Charcoal

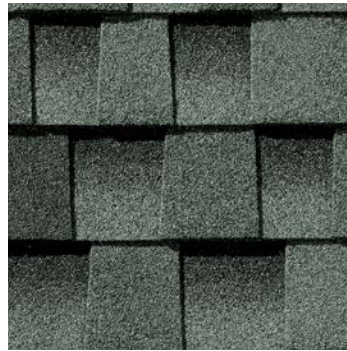

Slate



Birchwood



Hickory



Hunter Green



Pewter Gray



Mission Brown



Shakewood



Weathered Wood





SOFFIT & FASCIA

STANDARD

Polar White

EDCO soffit and fascia systems are designed to complement our homes. EDCO offers a 50-year transferable warranty that guarantees this product will not crack, chip or peel.

UPGRADE COLOR OPTIONS



Sandtone



Royal Brown



Desert Tone



Claytone



Black

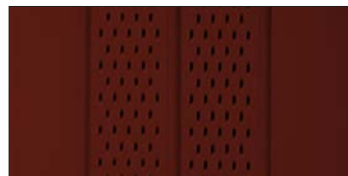

Classic Red



T-Tone



Statuary Bronze



Wickertone



Antique Parchment

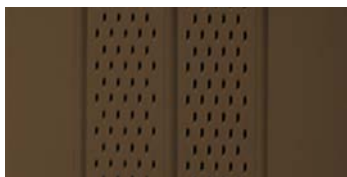

Cedarwood



Timber



Canyon



Adobe



Almond Cream



Driftwood Gray



Iron Gray

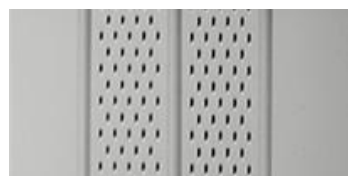

Glacier White



Charcoal Gray



EXTERIOR SIDING

STANDARD SIDING

CertainTeed Vinyl Siding. A woodgrain clapboard featuring a 9/16" panel projection, class 1(A) fire rating and a limited lifetime warranty! This siding is virtually maintenance free - you never need to paint it!



PROFILE

We offer a 4" double lap siding that is both sophisticated and timeless. This profile comes in any of the colors shown on page 21.

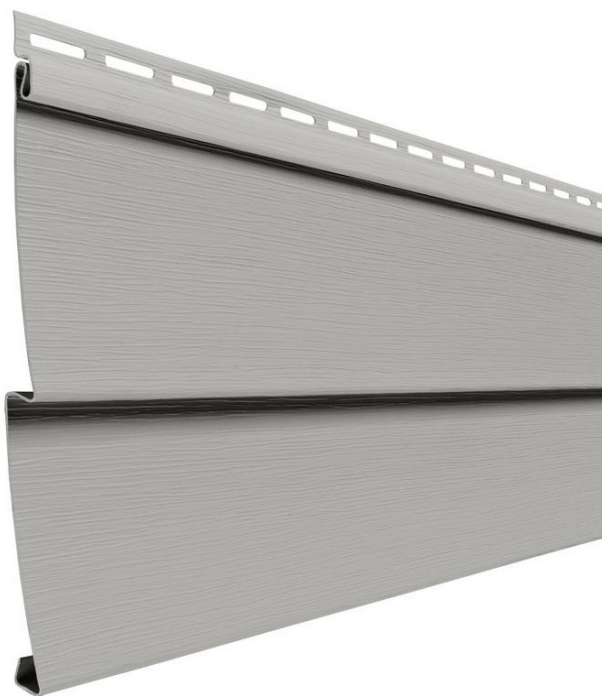

VINYL COLOR OPTIONS



Autumn Red



Brownstone



Buckskin



Castle Stone



Charcoal Gray



Colonial White



Cypress



Desert Tan



Espresso



Flagstone



Forest



Granite Gray



Hearthstone



Heritage Cream

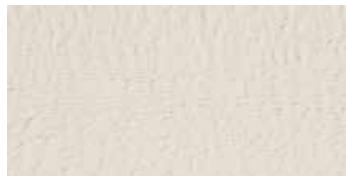

Herringbone



Light Maple



Melrose



Midnight Blue



Natural Clay



Olive Grove



Oxford Blue



Pacific Blue



Sable Brown

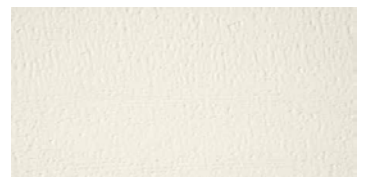

Sandstone Beige



Savannah Wicker



Seagrass



Slate



Smoky Gray



Spruce



Sterling Gray



Tuxedo



Weathered Wood



Wedgewood Blue

LP SMARTSIDE UPGRADE SIDING COLOR OPTIONS

SOLID SERIES

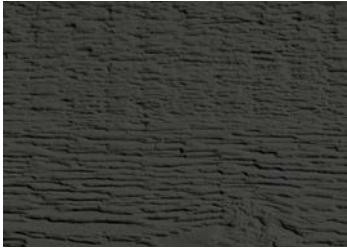

Abyss Black



Cavern Steel



Desert Stone



Tundra Gray



Sand Dunes



Terra Brown



Timberland Suede



Summit Blue



Redwood Red



Quarry Gray



Snowscape White



Rapids Blue



Harvest Honey

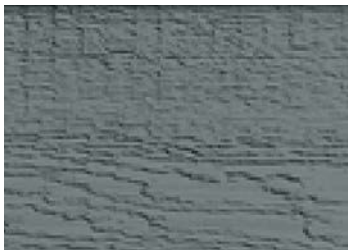

Midnight Shadow

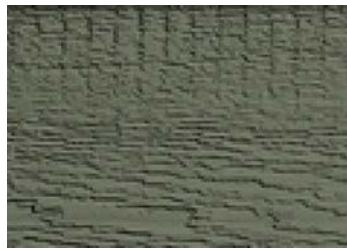

Garden Sage

Ask about our LP Smartside Board & Batten Vertical Siding and Shakes Options, available in Solid Series upgrade colors only.



At LP, we build with purpose-and it's our aim to help you do the same. Building a Better World is why we've engineered a product portfolio proven to stand up to the elements and designed for longer-lasting curb appeal. Let's build better together.

DIAMOND KOTE DUOBLEND UPGRADE SIDING COLOR OPTIONS

DUOBLEND



Bedrock



Canyon



Chesnut



Elkhorn





JamesHardie™

Classic shades—engineered with long-lasting ColorPlus® Technology—will make a statement that resonates for generations. The tried and true colors of James Hardie's Statement Collection™ products were designed for every home. They're our most popular hues. And they are readily available in your region. Includes 30 Year Non-Prorated Warranty

JAMES HARDIE UPGRADE PLANK LAP SIDING COLOR OPTIONS

SOLID SERIES

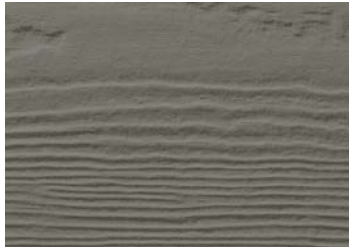

Aged Pewter

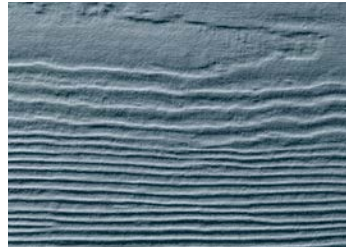

Boothbay Blue

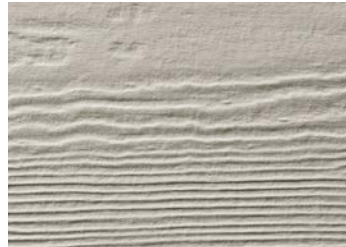

Cobblestone

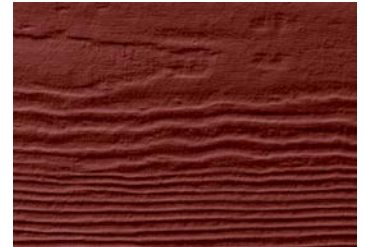

Countrylane Red



Deep Ocean

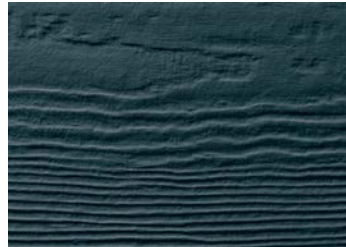

Evening Blue

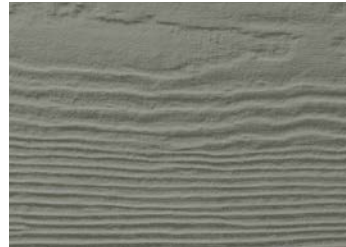

Gray Slate

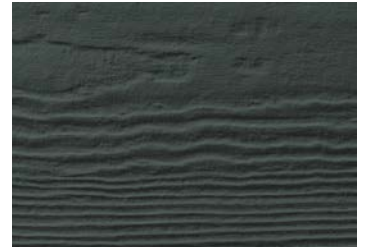

Iron Gray

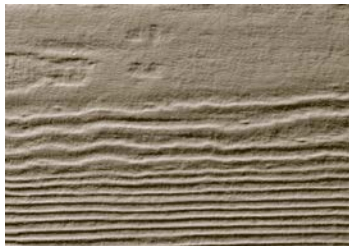

Khaki Brown

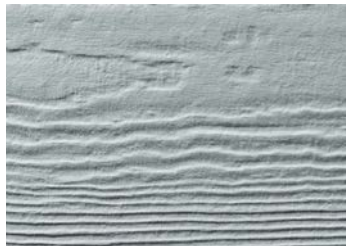

Light Mist

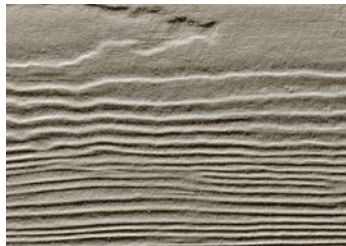

Monterey Taupe



Mountain Sage



Navajo Beige

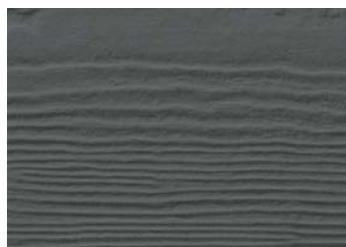

Night Gray



Pearl Gray

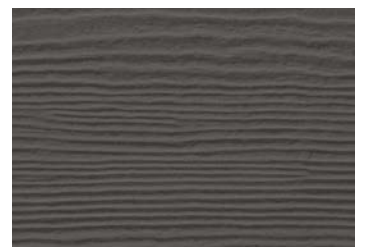

Rich Espresso

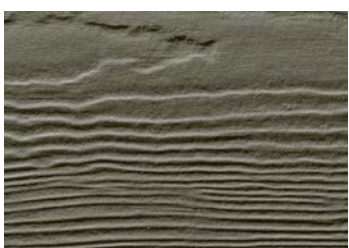

Timber Bark



Arctic White





EXTERIOR ACCENTS

VINYL SHAKES

NORTHWOODS® SINGLE 7" STRAIGHT EDGE ROUGH-SPLIT SHAKES

Vinyl Shakes: 7" straight edge rough split shakes with deep tapered shingle gaps for a beautiful, distinctive look.

VINYL SHAKE COLOR OPTIONS



Autumn Red

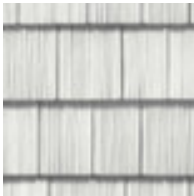

Colonial White

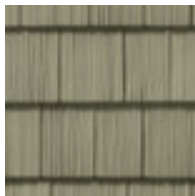

Cypress

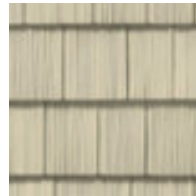

Desert Tan

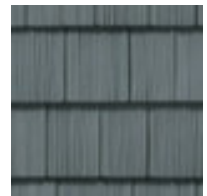

Flagstone

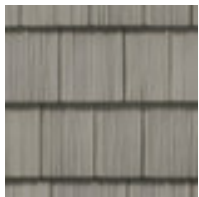

Granite Gray

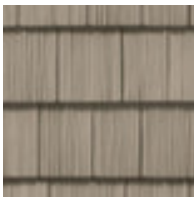

Natural Clay

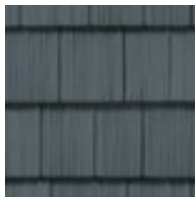

Pacific Blue

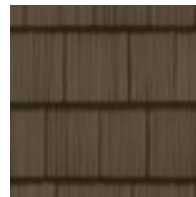

Sable Brown

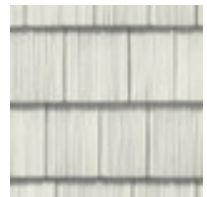

Sandstone Beige

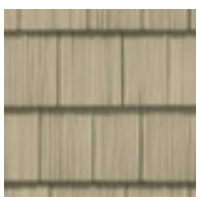

Savannah Wicker

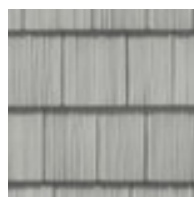

Sterling Gray

LP® SHAKES

LP® SmartSide® Cedar Shake Siding is a great choice for adding charm and character to any home. It's an affordable alternative to achieving the natural look of real shake siding with easy maintenance and upkeep. Use it for decorative accents or your entire home.



Prairie Clay



Cavern Steel



Desert Stone



Tundra Gray

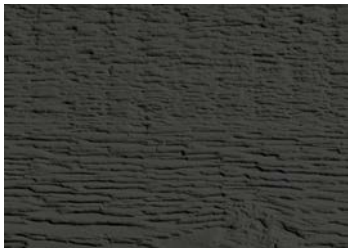

Abyss Black



Terra Brown



Timberland Suede



Summit Blue



Sand Dunes



Quarry Gray



Snowscape White



Rapids Blue



Redwood Red



Harvest Honey

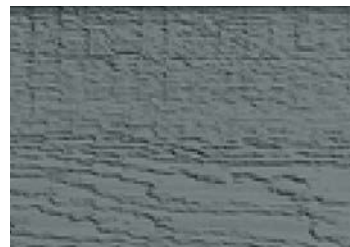

Midnight Shadow



Garden Sage

Ask about our LP Smartside Board & Batten Vertical Siding and Shakes Options, available in Solid Series upgrade colors only.





EXTERIOR OPTIONS

EVOLVE STONE

The Future of Stone The next evolution in decorative stone is here. Evolve Stone® is the most innovative stone veneer product to date, surpassing its predecessors in value, ease and accessibility. Formulated from patented Evolve Material, it is the very first stone cladding that can be face nailed in the same fashion as traditional siding, reducing installation time dramatically. Like natural stone, this proprietary material holds its color throughout, so it can be cut to fit on-site while maintaining the highest appearance standards.



Dune Point



Kodiak Mine



Winter Valley



Morning Aspen



Phantom Shadow

VINYL RAILING & POSTS

Harrington Rail systems are not only beautiful, but durable and virtually maintenance free. The UV-protected vinyl finish never needs painting! Pair one of the color options below with the decking of your choice for a stunning effect.



White

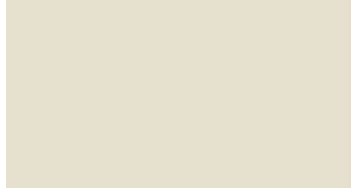

Tan



Khaki



ALUMINUM RAILINGS

durables[®]
Railing and fencing that last.

Durables[®] fencing and railing are easy to maintain and fully customizable. Our superior manufacturing blends elegant styling with durable technology to create a product that is built to last.



Textured Black Aluminum
Dalton Style

STANDARD DECKING

(On Plans that include a porch.)

Treated Decking

A strong and durable wood that is resilient in the face of environmental exposure and deterioration.



UPGRADE DECKING

Armadillo Evolution Composite Decking

Armadillo Evolution Composite Decking is as durable as it is beautiful. With Armadillo, you can enjoy the freedom and ease of outdoor living for years to come.



Firewood



Steel Wool



ARMADILLO 



WINDOWS

STANDARD VINYL WINDOWS

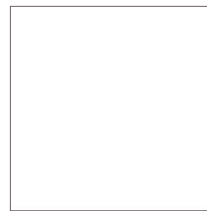

White



Tan



Sandlewood



Thermo-Tech Double-Hung Windows

- Top and bottom sashes tilt in for ease of cleaning.
- Flush mounted tilt latches.
- Smooth gliding balance system uses constant force coil that needs no adjusting and little or no maintenance.
- Die-cast lock and keeper hardware draws in the sash for secure and weather tight locking.
- Slope sill directs water runoff even in a driving rain.
- Dual weather-stripped interlocks at the meeting rail and double layered weather-stripping on the sashes maximize resistance to air, water and dust infiltration.

UPGRADE BLACK VINYL WINDOWS



White Interior



Black Exterior



Gerkin Double-Hung Windows

- Triple Weatherstripping: The 4800 sash and interlock have triple weatherstripping providing for a very tight window.
- Patented Jamb Design: Our "Candy Cane" jamb design allows a full jamb-to-jamb interlock and equal dimensional sashes with a clean traditional appearance.
- One Piece Sloped Sill: Our double hung utilizes a fully sloped, weepless sill design. This provides for excellent drainage and air infiltration performance. Die-cast lock and keeper hardware draws in the sash for secure and weather tight locking.
- Slimline beveled frame appearance and equal lite sash offers maximum open viewing.
- Aluminum Reinforcement: Both sashes are reinforced with extruded aluminum stiffeners around the full perimeter of the sash. The sill is also reinforced with an aluminum stiffener.



UPGRADE FIBERGLASS WINDOWS

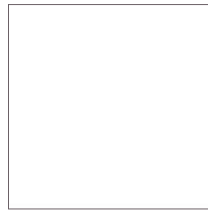

White



Black



Pella Fiberglass Windows

- Rot- and corrosion-free
- Our extremely durable fiberglass will never rot or corrode and is naturally resistant to water and bugs.
- Take the heat (and subzero cold)
- Tested from -40°F to 180°F , our fiberglass is engineered to withstand subzero cold, the most extreme heat and the rigorous performance requirements of a commercial building.
- No painting or refinishing
- With a heavy-duty powder-coat finish, Pella fiberglass windows resist chipping, chalking and fading — so you never need to paint or refinish.
- Exceptionally energy-efficient
- Energy-efficient dual- and triple-pane glass options with argon help slow the transfer of heat, keeping your home more comfortable year-round



UPGRADE WINDOW GRILLE OPTIONS

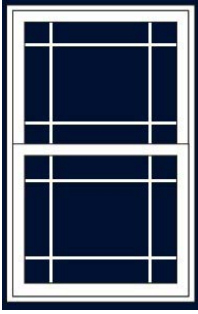

Upgrade: Prairie

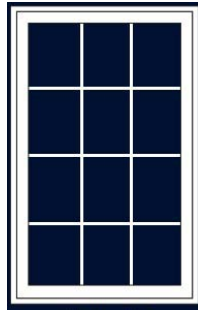

Upgrade: Colonial

Available in Thermo-Tech, Gerkin and Pella brands.

UPGRADE WINDOW/DOOR OPTIONS

All Window options available with Thermo-Tech, Gerkin and Pella brands.

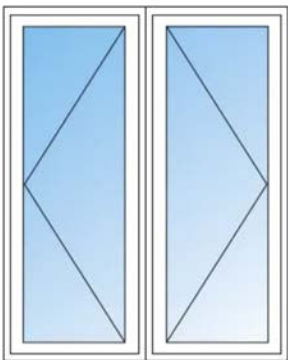

Casement Windows

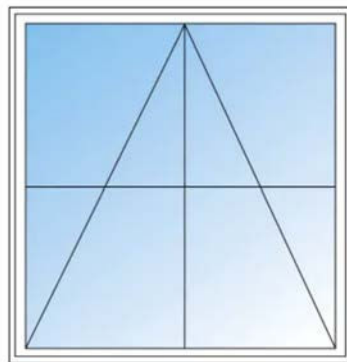

Awning Windows

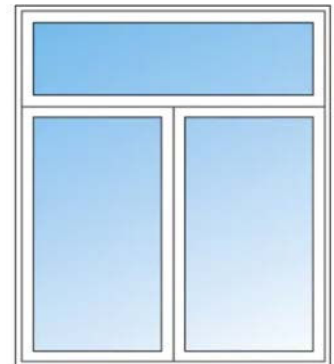

Transom Windows
Glider shown with transom above



French Door
(Bayer Built)

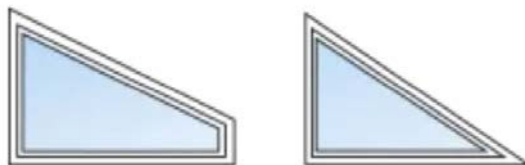

Trap Windows

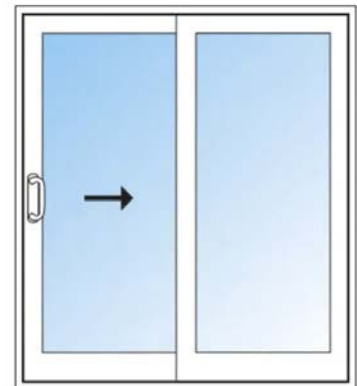

Sliding Patio Door
Available in 6' and 9' width



EXTERIOR DOORS

STANDARD DOOR

UPGRADE PAINT COLOR OPTIONS



2 Panel Steel - Primed White

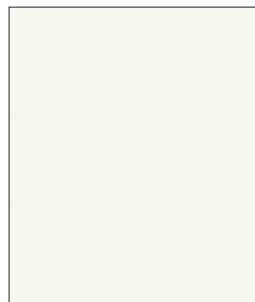

White



Evergreen



Cobalt Blue

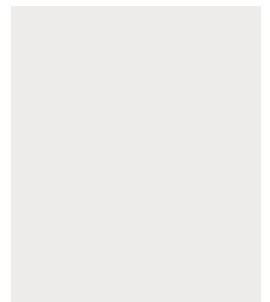

French Cream



Shutter Blue



Burgundy Wine

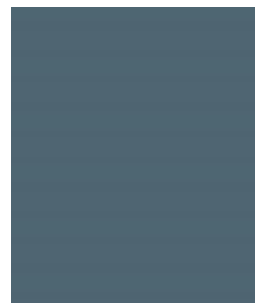

Evening Gray



Steel

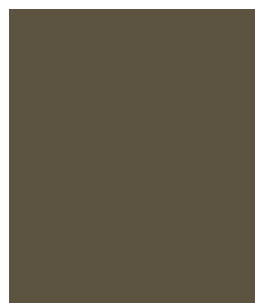

Terratone



Sandtone



Black



Medium Bronze

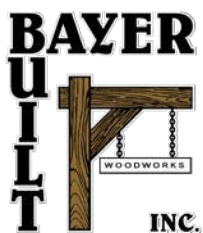

FIBERGLASS UPGRADE PAINTABLE OPTIONS

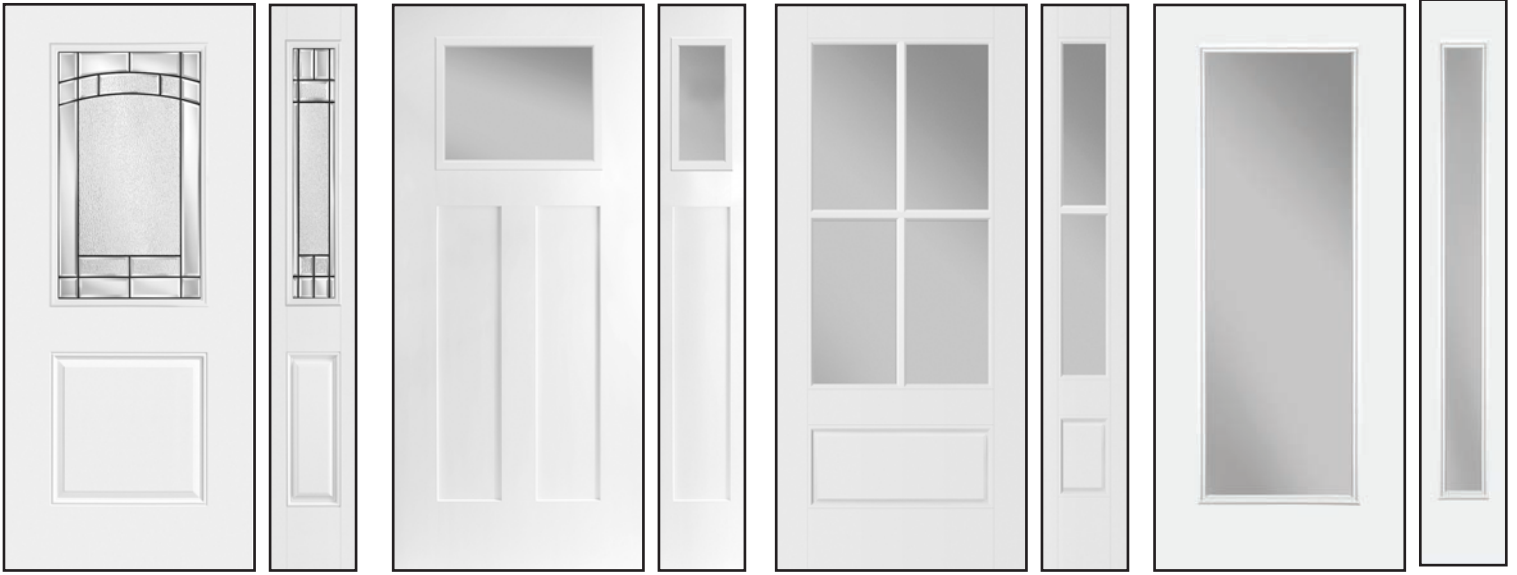

Door: 1/2 Decorative Glass
Sidelight: Matching Door

Door: 1/3 Clear Glass
Sidelight: Matching Door

Door: 2/3 Clear Glass
with Grilles
Sidelight: Matching Door

Door: Full Clear Glass Door
Sidelight: Matching Door

*White Standard, Can be painted to match any color on page 34 (upgrade).

FIBERGLASS UPGRADE WOOD GRAIN OPTIONS*



Door: 2 Panel Door
Sidelight: Full Clear Glass

Door: 1/3 Clear Glass
with Grilles
Sidelight: Matching door

Door: 2/3 Clear Glass
with Grilles
Sidelight: Matching Door

Door: Full Clear Glass
Sidelight: Matching Door

*Can be stained to match any color on page 41.

You never have a second chance to make a first impression...

An impressive front door is an investment you will never regret.

Bayer Built's Acclimated Entry Systems™ door options are not only IMPRESSIVE, they are built to last! All standard and upgrade door options come with the same great features listed below. Bayer Built doors are built with a combination of premium components designed to withstand the extreme conditions of the Midwest climate.

FrameSaver® Door Frames: A frame that performs! Rot-Proof. Worry-free. FrameSaver protects you for life. Upgrade to an Aluminum Clad Frame for Stellar Performance!





EXTERIOR DOOR HARDWARE

STANDARD DEADBOLT



Standard Satin Nickel

STANDARD KNOB



Polo Satin Nickel



Black

UPGRADE ELECTRONIC DEADBOLT



Powerbolt Satin Nickel



Powerbolt Black

UPGRADE LEVER OPTIONS



Balboa Satin Nickel



Balboa Black



Henley Nickel



Henley Black



Milan Satin Nickel



Milan Black

With a lifetime mechanical and finish warranty, and a one year electronic warranty, you know this hardware will be welcoming you home for years to come!

Kwikset

UPGRADE HANDLESET OPTIONS



Henley Satin Nickel



Henley Black



Amador Satin Nickel



Amador Black





DOORS



RAILINGS



FLOORING



CABINETRY



COUNTERTOPS



SINKS/FAUCETS



LIGHTING



FIREPLACES



APPLIANCES

INTERIOR

Options

Interior Doors	40
Interior Door Hardware	45
Mouldings	46
Railings	48
Drywall	50
Closets	53
Wood Accents	54
Carpet	57
Cushioned Vinyl	58
Luxury Vinyl Tile	59
Luxury Vinyl Plank	60
Hybrid Rigid Core	61
Waterproof Hardwood	62
Floor & Wall Tile	64
Shower Walls	68
Cabinetry	70
Hardware Options	77
Accessories	78
Vanity Options	80
Boot Benches	82
Countertops	84
Sinks	90
Faucets	93
Bath Accessories	96
Bathroom Fixtures	100
Lighting	104
Electrical	109
Fireplaces	110
Appliances	114
Water Heaters & HVAC	126
Comfort Options	128
Standard Specifications	131

Create the Interior of your Dreams!

Northstar Systembuilt is able to offer a wide range of Interior Options to turn your ideas into the home of your dreams.

We are not your '**cookie cutter**' factory offering you limited choices. Colors, textures, finishes, the choice is yours. From a French country feel to a Rustic chalet, **we build each home to suit you by combining continuity of style with your daily needs.**

We present to you a house that is home before you move in.



INTERIOR DOORS

STANDARD PAINT FINISH OPTIONS

(Available for Molded only)

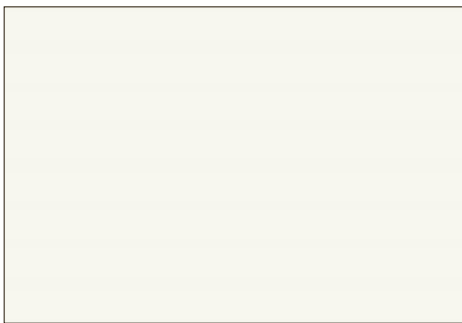

White 99

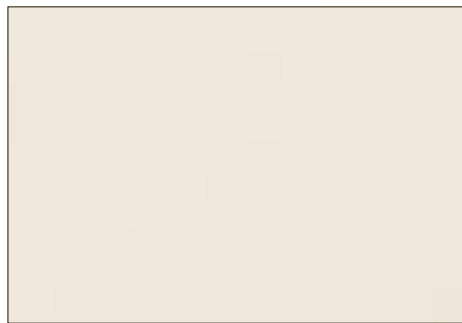

Divinity

TYPE / SPECIES

STANDARD

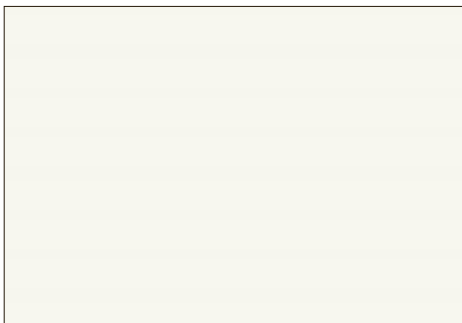

Molded

UPGRADE



Oak



Knotty Pine



Poplar



Knotty Alder

UPGRADE FINISH OPTIONS

Color swatches shown below are for reference purposes only. Colors may vary between wood species. For accurate color representation, please ask your dealer to see the Bayer Built Pre-Finish Color Selection Tools.

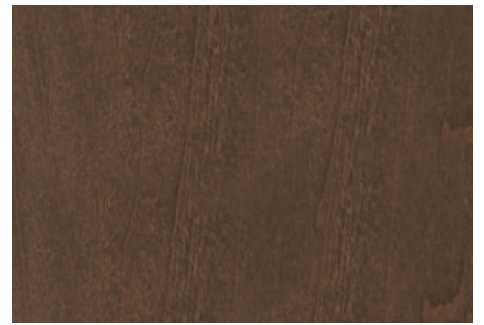

Crimini

STAIN FINISH OPTIONS



Clear Coat

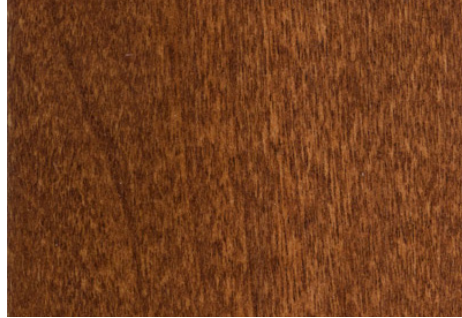

Pecan



Marmot

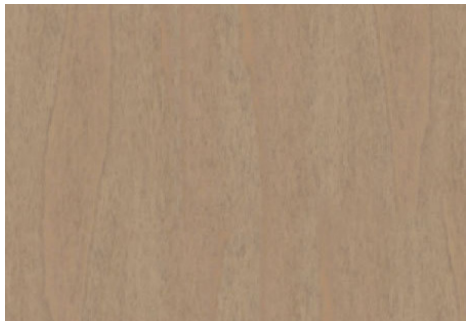

Sycamore

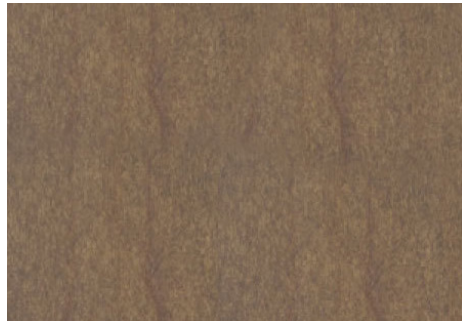

Zinc

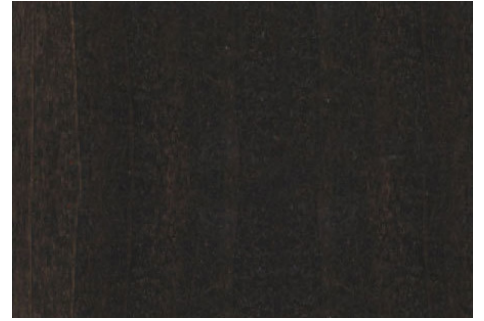

Carbon

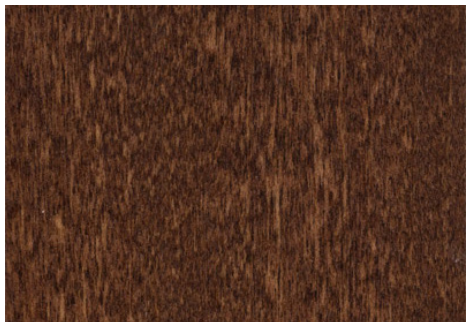

Pinecone

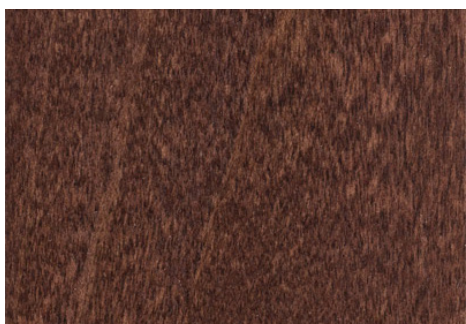

Macchiato

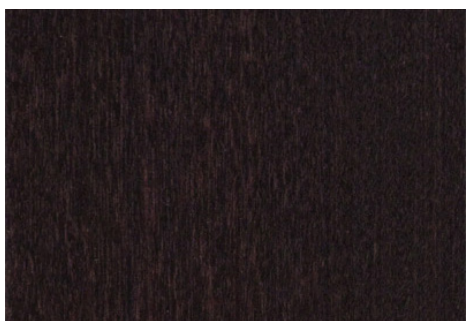

Dark Roast



STANDARD (SOLID CORE)



Model A6

Available in: Oak,
Molded, Knotty Pine &
Poplar

UPGRADE FRENCH/PANTRY



Model 1515

Available in: Oak,
Molded, Knotty Alder
& Poplar



Model 1501 Rain

Available in: Oak,
Poplar & Knotty Alder

UPGRADE STYLE OPTIONS (SOLID CORE)



Model B2

Available in: Oak,
Molded, Poplar &
Knotty Alder



Model F2

Available in:
Molded, Knotty Pine
& Knotty Alder



Model A3

Available in: Oak,
Molded, Poplar, Knot-
ty Alder & Knotty Pine

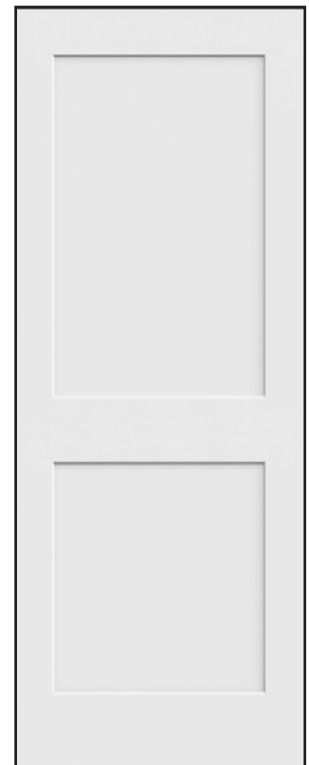

Model A2

Available in:
Molded, Poplar,
Oak & Knotty
Alder



BARN DOORS

UPGRADE BARN DOOR STYLES



Classic 3 Panel
-Craftsmen



Diagonal Rail-Z



4 Panel

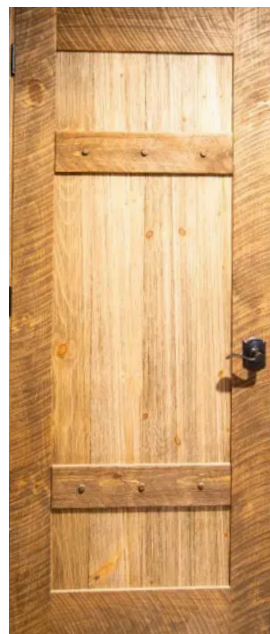

Split 3 Panel

HARDWARE

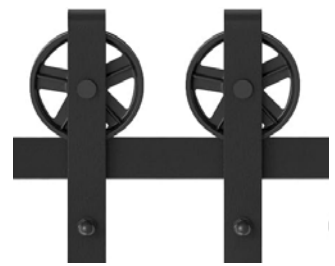

Wheel Rollers



Black



Satin
Nickel

STAIN OPTIONS



Desert Burn



50 Year Old



100 Year Old



Red Barn



White Wash



Black
Handle



Nickel
Handle

Barn doors are a creative twist on pocket doors. They serve dual function (privacy and decor) without taking up extra space in a room or needing to worry about electrical, plumbing, or vents on the other side. Please note that any style of door from page 40 can be used with the barn door hardware





INTERIOR DOOR HARDWARE

With a lifetime mechanical warranty and a 5 year warranty on the finish, you know this hardware will be welcoming you home for years to come!

STANDARD KNOB



Land's End (Regina)
Satin Nickel

UPGRADE KNOB OPTIONS



Marina Satin Nickel



Marina Black

UPGRADE HANDLE OPTIONS



Sea Cliff Satin (Grapevine)
Satin Nickel



Skyline Blvd (Reminy)
Satin Nickel



Twin Peaks (Layton)
Satin Nickel



Pocket Door
Satin Nickel



Sea Cliff (Grapevine)
Black



Skyline Blvd (Reminy)
Black



Twin Peaks (Layton)
Black



Pocket Door
Black



Kwikset



MOULDINGS

STANDARD



Casing: 9/16"x3"
Model: 155
 Available in:
 Oak
 MDF (Std)
 Knotty Pine
 Poplar
 Knotty Alder

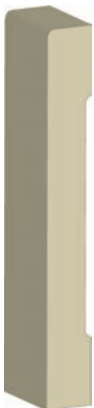

Base: 7/16"x3 1/4"-4 1/4"
Model: 238/239
 Available in:
 Oak (4 1/4")
 MDF (5") (Std)
 Knotty Pine (4 1/4")
 Poplar (4 1/4")
 Knotty Alder (3 1/4")

UPGRADE



Casing: 1/2"x2 1/4"
Model: 115
 Available in:
 Oak
 MDF
 Knotty Pine
 Poplar



Base: 3/8"x2 3/4"
Model: 219
 Available in:
 Oak
 MDF
 Poplar
 Knotty Pine (3 1/4")
 Knotty Alder (3 1/4")

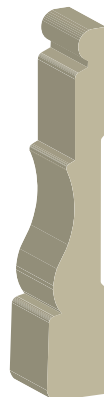

Casing: 9/16"x3 1/4"
Model: 178
 Available in:
 Oak
 MDF
 Knotty Pine
 Poplar
 Knotty Alder



Base: 1/2"x4 1/4"
Model: 279/280
 Available in:
 Oak
 MDF (5")
 Knotty Pine (5 1/8")
 Poplar
 Knotty Alder



Base: 9/16"x7"
Model: 240
 Available in:
 Oak
 MDF (7 1/4")
 Poplar
 Knotty Alder

UPGRADE DOOR TOPPERS



Classic Topper

Available in:
Oak, Poplar, Knotty Alder

Per Door/Per Side available



Cabin Topper

Available in:
Oak, Poplar, Knotty Pine, Knotty Alder

Per Door/Per Side available





RAILINGS

STANDARD



Half Wall with Millwork Cap

UPGRADE BALUSTERS



Baluster
5060



Log Railing & Baluster
(Knotty Pine Clear Coat)



Baluster
5516
(Hollow)



Baluster
5512
(Hollow)

UPGRADE RAILS & NEWEL POSTS

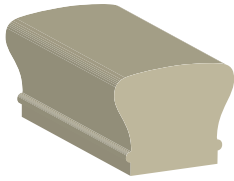

Rail 6210

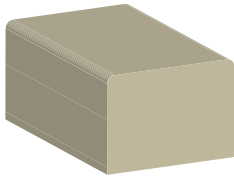

Rail 6770



Newel
4001ch

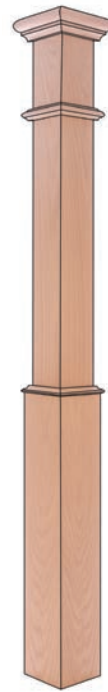

Box Newel
4090*

*Not available in Knotty Pine.





DRYWALL FINISHES

DRYWALL FINISH & CORNERS



Standard: Orange Peel

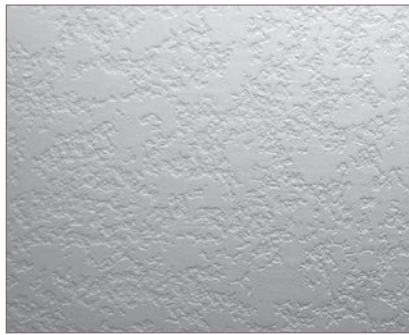

Upgrade: Knockdown

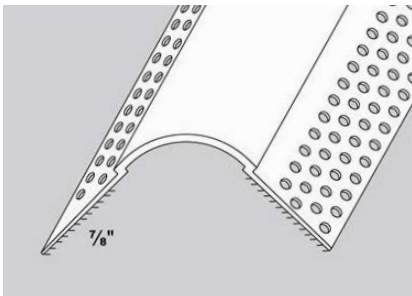

Bullnose Corner

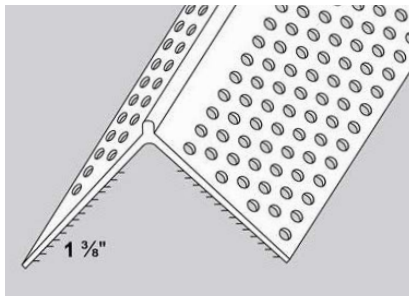

90 Degree Corner

STANDARD PRIMER COLOR OPTIONS

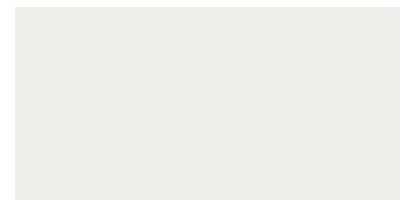

White

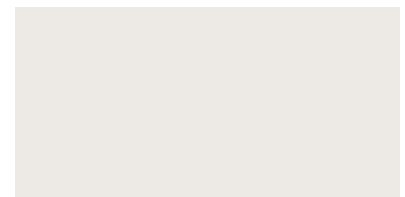

Snowbound



Accessible Beige



Amazing Gray



Repose Gray



SHERWIN-WILLIAMS.

All walls and ceilings throughout the entire home can be finished in any one of the 5 Standard Primer Color Options ready for top coat to be applied on site if required.

UPGRADE DRYWALL FEATURES

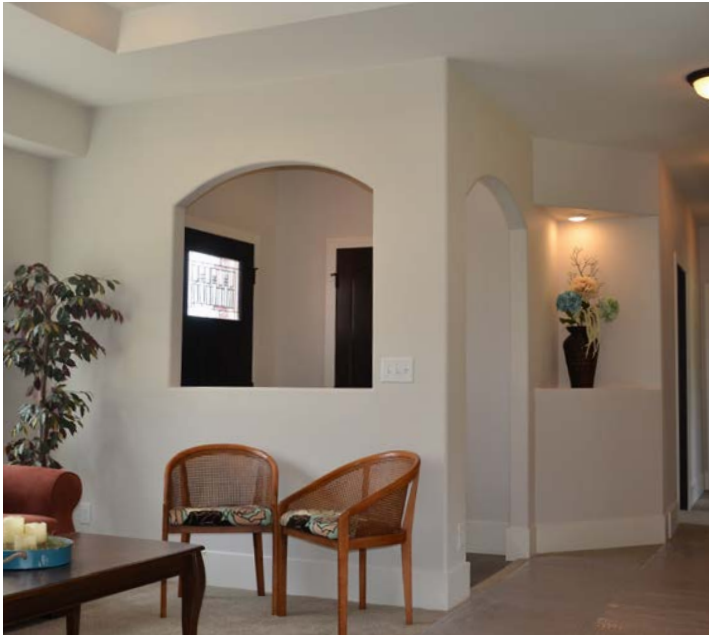

Arched Openings



90 Degree Tray Ceiling



45 Degree Tray Ceiling



Double Tray Ceiling





CLOSETS

STANDARD



Bedrooms - one level of wood shelving, with built-in hanging rail. Shelving height at 69"



Linen - three levels of wood shelving
Pantry - five levels of wood shelving

UPGRADE CLOSET OPTIONS



Option 1
Size - 24" x 83"



Option 2
Size- 24" x 83"



Option 3
Size - 24" x 83"



Option 4
Size - 32" x 83"



Double Shelf and Rod
Double shelving heights - 42" bottom and 83" on top
(Shown with Option 3 Shelf Tower)

All closets options are White only.



WOOD ACCENTS

BEAMS

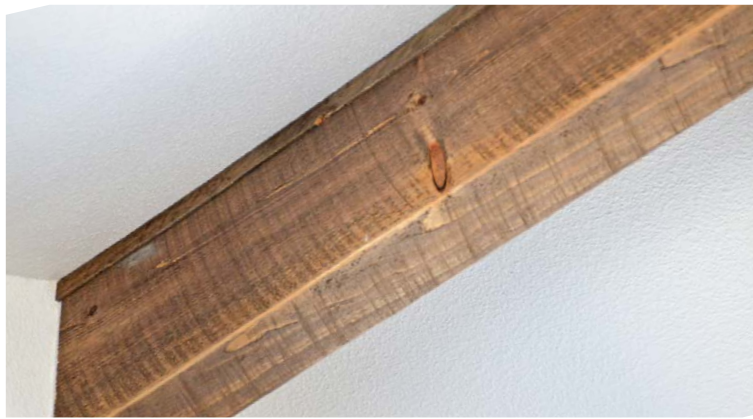

Traditional Timber Beam 4"x 7"
(See color options on page 47)



Pine or As-Is Barnwood Wrapped Beams
(Pine Wrapped Shown Above)

AS-IS BRAND BARNWOOD

Create beautiful accent walls, wrap posts or islands with AS-IS Brand reclaimed wood. Variation in each color and tone is natural and super cool! These variations come from their aging process, natural wood undertones, and the unique wood grains and characteristics.



Raw-ish



Black-ish



Blue-ish



Grey-ish



Red-ish



White-ish

PINE CEILINGS



Natural



English Chestnut



Cherry

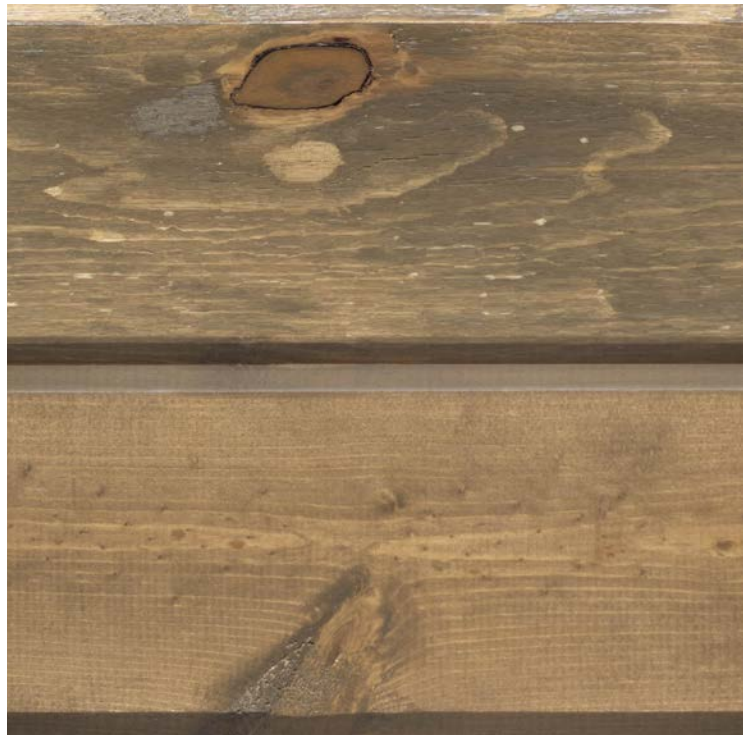

Pewter





Don't see a flooring option that fits your style?

At Northstar Systembuilt we aim to please! If you don't see the carpet, laminate, engineered wood, or tile of your dreams don't fret. Just ask about our **'omit flooring option'** and we'll leave your floors prepped and ready to be finished in whatever flooring option you choose.

CARPET

STANDARD FLOORING OPTION

R2x® SOIL AND STAIN RESISTANCE True Spirit features Shaw's R2x® combined soil and stain resistance system, a patented treatment that offers a 15-year limited warranty against soiling and liquid spills.



TRUE SPIRIT

40 oz Face Weight, 100% Nylon

Style: 229SE



502 Lady Liberty



507 Concrete



511 City Space



701 Truffle



705 Cottage



Cottage



Congoleum®

CUSHIONED VINYL

STANDARD FLOORING OPTION



LX310 | Farmstead



LX153 | Rain Dance



LX150 | Honeytone



LX328 | Whiskey



LX275 | Vintage White



LX327 | Aspen



LX277 | Greige



LX290 | Cafe Au Lait



LX292 | London Fog



LX350 | Dusty Acorn



LX311 | Natural



LX355 | Beachside



LX326 | Walnut



LX330 | Harbor Light



LX360 | Playtime



LX301 | Highlight

A closely matching solid color transition strip will be used when the vinyl crosses a mating line between 2 modules. *(Not Available for Stairwells)*

LUXURY VINYL TILE

UPGRADE FLOORING OPTION (LVT)

12" x 24" Tiles | 22mil Wear Layer | 5mm Thickness *(Not Available for Stairwells)*



Dove



Clay



Shadow



Shell

Pure Tile Floor by BeauFlor is a pet and kid-friendly floating luxury vinyl tile that keeps messes on the top surface ready to clean. 100% waterproof with an attached underlayment, this flooring option reduces sound transfer and provides superb walking comfort.

Pure Plank Floor by BeauFlor is a pet and kid-friendly floating luxury vinyl plank that keeps messes on the top surface ready to clean. 100% waterproof with an attached underlayment, this flooring option reduces sound transfer and provides superb walking comfort.



LUXURY VINYL PLANK

UPGRADE FLOORING OPTION (LVP)

8" x 52" Planks | 22mil Wear Layer | 5mm Thickness *(Not Available for Stairwells)*



Mink

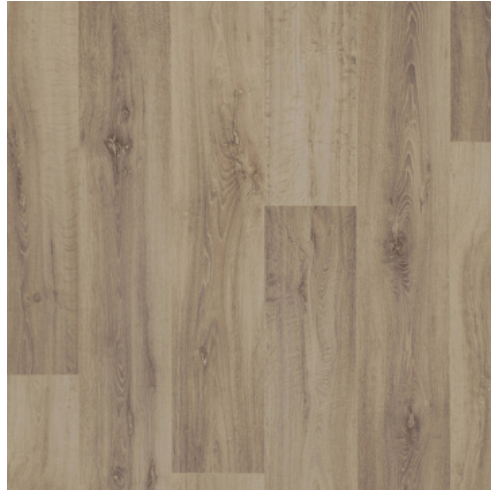

Saddle



Mocha



Ash



Walnut



Coffee



Pearl
60 |



Russett



Pictured: Saddle

MSI's Smithcliffs™ features extra-thick solid core construction, with a pre-attached, 2MM closed-cell comfort & acoustic pad, patent-pending DryLuxe™ technology, 100% waterproof protection and the new CrystaLux Ultra™ protection layer, providing durability and longevity, protecting against everyday wear, with additional Anti-Microbial protection built in.

MSI

HYBRID RIGID CORE

UPGRADE FLOORING OPTION (Waterproof Hybrid Rigid Core)

7" x 48" Planks | 20mil Wear Layer | 10mm Thickness (8 mm core, 2 mm attached pad)



Avery Ash™



Brockton™



Delray™



Driftway™



Emridge™



Hillsdale™



Malton™



Glenbury Oak™



Lanston Oak™

WATERPROOF WOOD

UPGRADE FLOORING OPTION

WOODHILLS® WATERPROOF WOOD FLOORING COLLECTION Enhance your space with the beauty and luxury of natural wood flooring with the Woodhills Collection. The series features a genuine wood top, hand-selected and scraped for the look and feel of top-range wood. Available in 6.5x48 featuring variable-length planks, showcasing the rich and natural aesthetic of hand-select wood flooring, the series is 100% waterproof, so it will last for years to come.



Color: Aaron Blonde
Species: Oak
Size: 6 1/2" x 48"



Color: Aura Gold
Species: Oak
Size: 6 1/2" x 48"

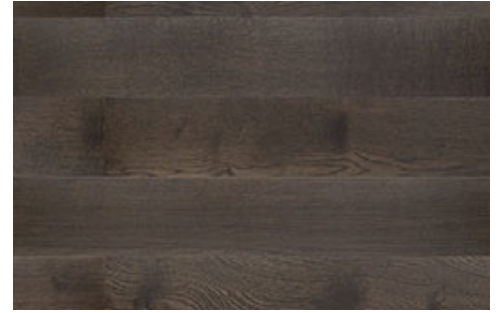

Color: Estate Oak
Species: Oak
Size: 6 1/2" x 48"



Color: Brooks Timber
Species: Hickory
Size: 6 1/2" x 48"



Color: Chesnut Heights
Species: Oak
Size: 6 1/2" x 48"

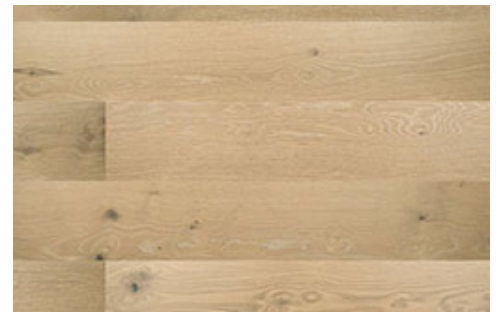

Color: Kings Buff
Species: Oak
Size: 6 1/2" x 48"

STILL DON'T SEE A FLOORING OPTION THAT FITS **YOUR STYLE?**

Just ask about our '**omit flooring option**' and we'll leave your floors prepped and ready to be finished in whatever flooring type you prefer.

MSI



Building with Northstar was a great experience from start to finish. We felt the customization process and attention to detail is what sold us on Northstar Systembuilt. Our dream home plan started as a sketch on a napkin and was made reality by Northstar. We loved our home the moment we saw it in the plant being built and have loved it ever since it was craned on and put together.

They have built us a quality home and stood behind everything that they did. We would not hesitate to have them build us another home. As a matter of fact, that is our plan when we retire."

RYAN & ANGIE V
- WARSAW, MN





FLOOR & WALL TILE

UPGRADE FLOOR | WALL TILE OPTIONS



Potenza Gray | 12"x 24"



Potenza Fawn | 12"x 24"



Potenza Dove | 12"x 24"



Pictured: Culver Sand



By offering unparalleled service and a dynamic selection of products, Emser is one of the most comprehensive sources for interior and exterior products that include porcelain, ceramic, metal, glass, quarry, decorative accents and mosaics, cut-to-size stone, setting materials, and custom manufactured products made to your specifications.



Culver Gray | 12"x 24"



Culver Sand | 12"x 24"

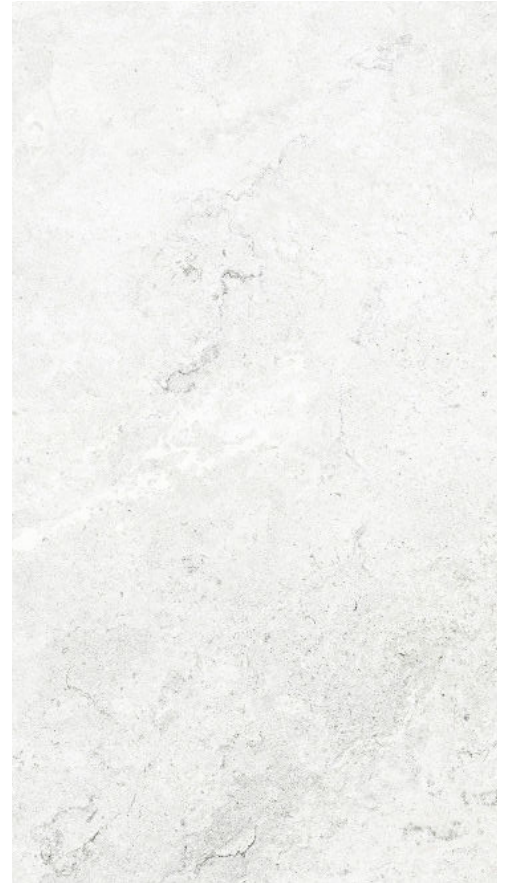

Culver White | 12"x 24"



Contessa | 12"x 24"



Acero | 7"x 24"



Bosso | 7"x 24"



Cedro | 7"x 24"

UPGRADE BACK SPLASH/FEATURE TILE OPTIONS



White Gloss Subway Tile | 4"x 10"

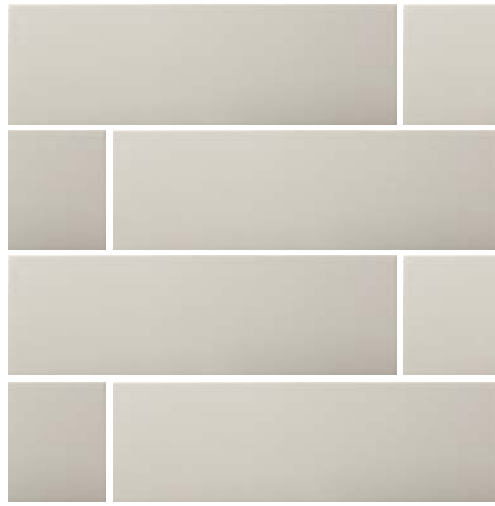

Fawn Gloss Subway Tile | 4"x 10"

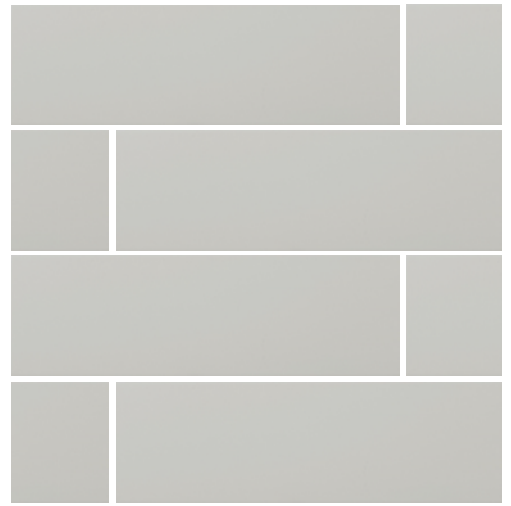

Gray Gloss Subway Tile | 4"x 10"

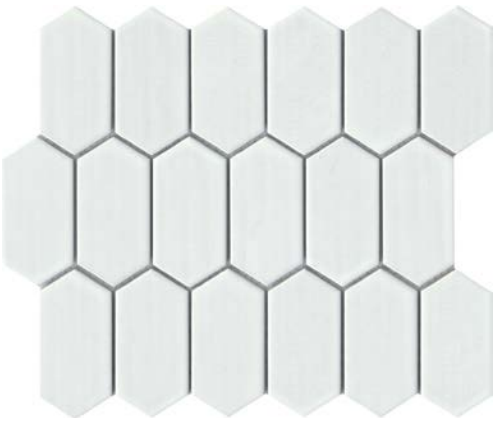

Omni White | 10" x 12"

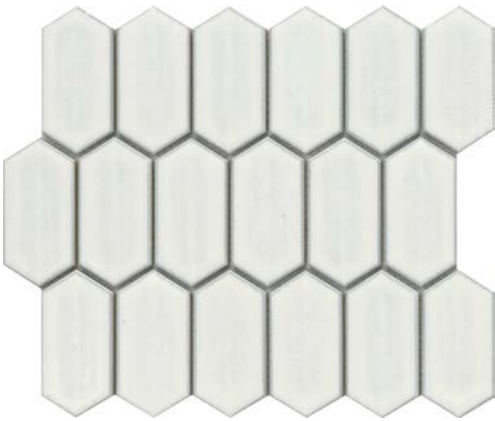

Omni Ivory | 10" x 12"

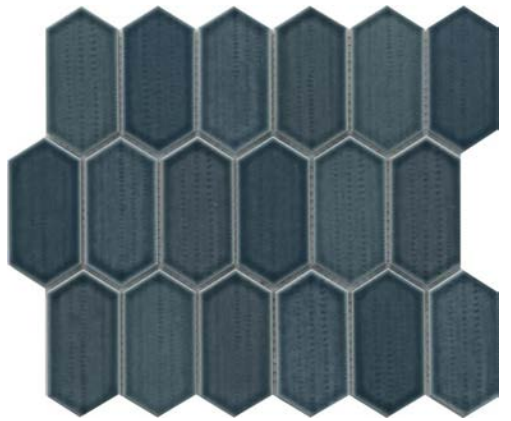

Omni Navy | 10" x 12"



Diagram | 9"x 9"



Mural | 9"x 9"



Outline | 9"x 9"

GROUT COLORS (TEC)

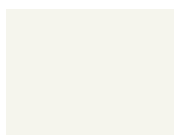

Bright White

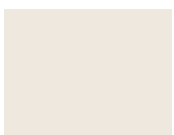

Pearl



Silverado



Light Smoke



Charcoal Gray

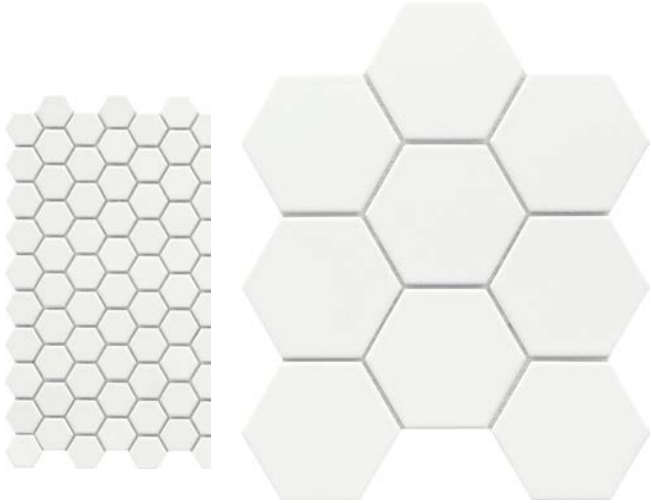

Source White | 3" or 1"

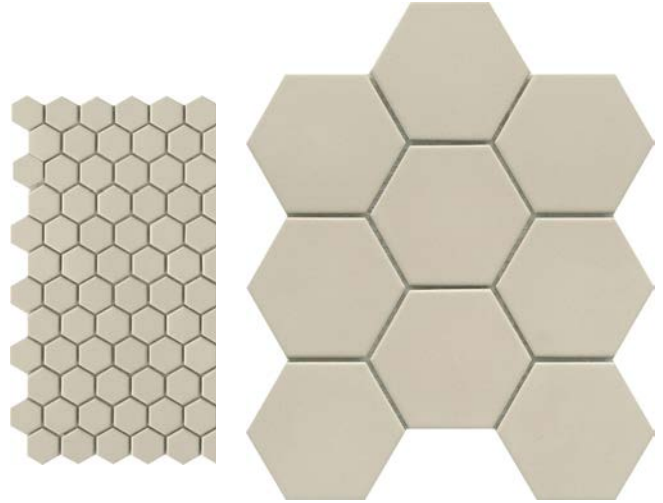

Source Fawn | 3" or 1"

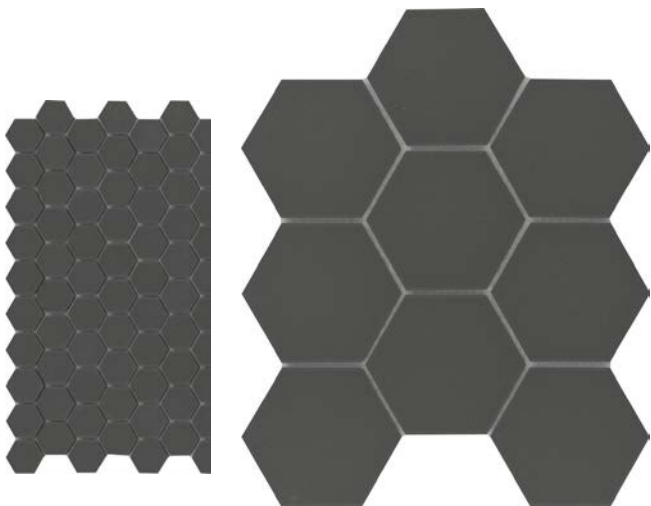

Source Black | 3" or 1"

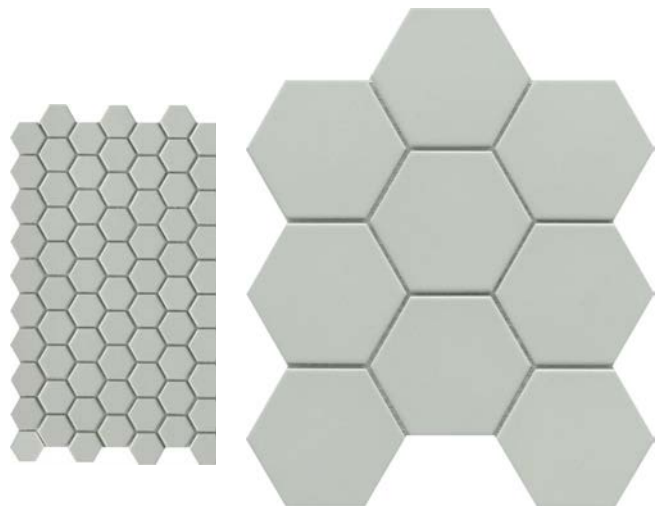

Source Gray | 3" or 1"

Source available in 3" (9"x10") sheets or 1" (11"x11" sheets)



Cognito Matte White 2x8"
(12x12 sheets)

UPGRADE SHOWER WALL OPTIONS



Waterproof and high resistance to impact and chemicals .

A Grout-Free Solution, allowing you to have the look of tile without the messy clean-up.

Walls can be cut to fit around either a shower or bathtub configuration.

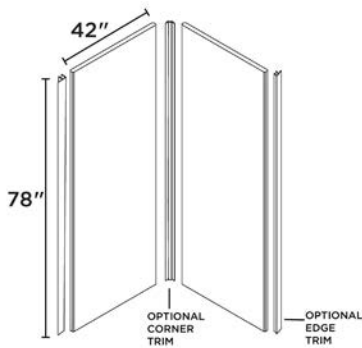

42" NEO ANGLE
42" W X 42" D X 78" H
2 Panels | 5 Finishes

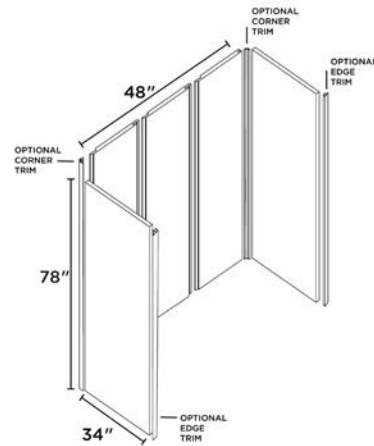

48" NEO ANGLE
48" W X 34" D X 78" H
5 Panels | 6 Finishes

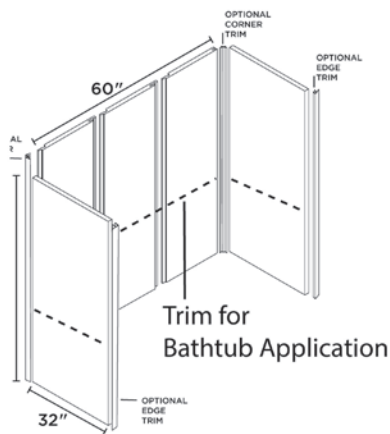

60" SHOWER/BATH
60" W X 32" D X 78" H
5 Panels | 7 Finishes

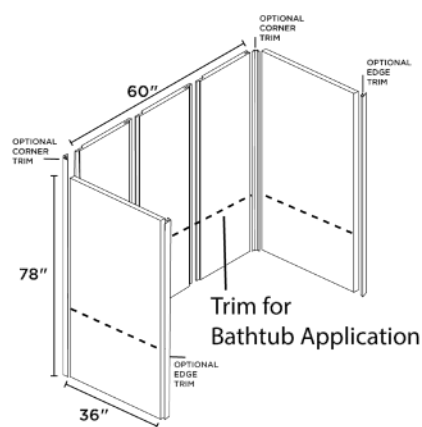

60" SHOWER/BATH
60" W X 36" D X 78" H
5 Panels | 4 Finishes

*Please refer to the instruction manual on how to properly install the Jetcoat® Shower Wall System over existing tile. Purchase of additional trim may be required.

DESIGN OPTIONS

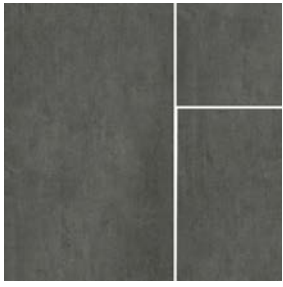

Slate

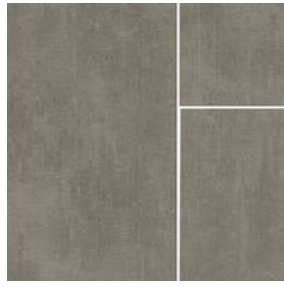

Quarry

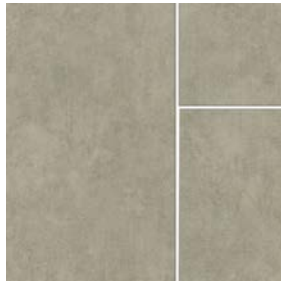

Shale



Driftwood

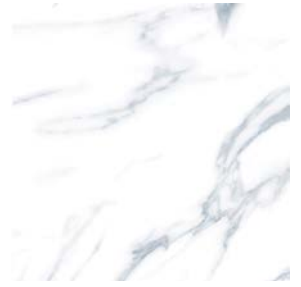

Carrara White Marble



Cortona



Tulipa



Polished Grey
Marble



Vertical White
Subway

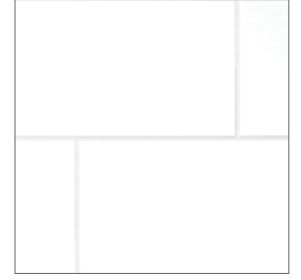

White Subway





CABINETS

WHAT IS FULL ACCESS CABINETS?



1. We use white, 5/8" thick eco-friendly, TFL Panels with PVC edgebanding in a matching color, for the complete construction of our cabinet boxes. Absolutely no 1/4" panels anywhere!
2. Flush bottom, top, and finished ends for a furniture like appearance.
3. Full depth, adjustable shelves to maximize storage space.
4. No lip or center dividers to give the most access and storage space inside your cabinets
5. Steel, fully-concealed, clip-on/off, self-closing, 110°, 6-way adjustable hinge with a lifetime manufacturer's warranty and soft close operation.
6. Our space saving drawers use a double wall, full extension metal side system with integrated soft close that provides 11% more room inside than face-frame cabinet drawers. The back and bottom are made using 5/8" TFL for max strength and durability.



SPECIES & DOORS



OAK

Oak, is characterized by its wide open grain patterns and extreme durability. Variations in grain pattern and color, small knots and pin holes are attributes of nature giving oak its distinctive beauty. Natural occurring color variation includes light tan to medium red and brown. These characteristics are more prominent in light finishes.



MAPLE

Maple offers a smooth, closed grain pattern, generally off-white in color with varying tones of light pink and yellow-brown. Maple contains a resin that causes the wood to turn amber as it ages. This will be more noticeable with light finishes.



RUSTIC HICKORY

Hickory is known for its strength, open grain and distinctive color variation within each piece. Ranging from light to deep brown, Hickory's unpredictable color spread is especially noticeable in light finishes. Rustic Hickory incorporates large sporadic knots and pin holes. These characteristics are acceptable and not considered warranty defects.



RUSTIC ALDER

Rustic Alder has a fine, straight-grain pattern and even texture. The color is a light red brown that stains evenly. Rustic Alder includes character spots, knots, and blemishes which do not affect the product durability. As a softer hardwood, alder can be easily dented or scratched. These characteristics are not considered warranty defects.

STANDARD



Concord
Flat Center Panel
Veneer



Horizon
Flat Veneer Panel

UPGRADE STYLES



Parker
Flat Center Panel
Veneer



Duncan
Raised Center Panel
Solid Wood



Jacobsen
Flat Center Panel
Solid Wood

STANDARD CABINET PAINT FINISH OPTIONS

Paint is an finish that provides solid coverage and a smooth satin sheen for a timeless look.
Standard on Concord and Horizon.

Midnight Sun



Carte Blanche

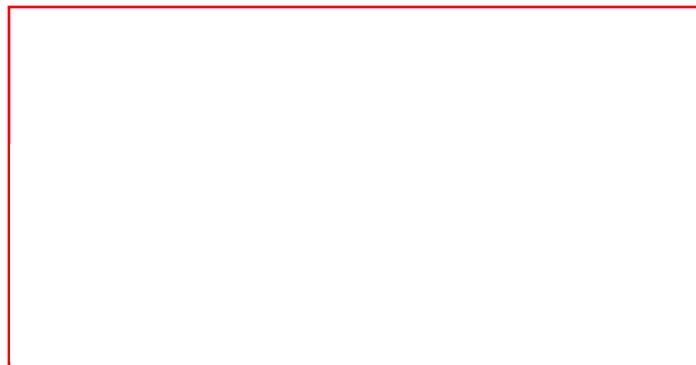

Black

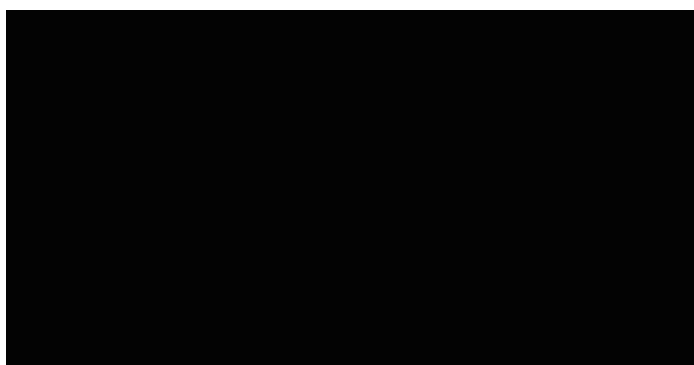

Morning Dew

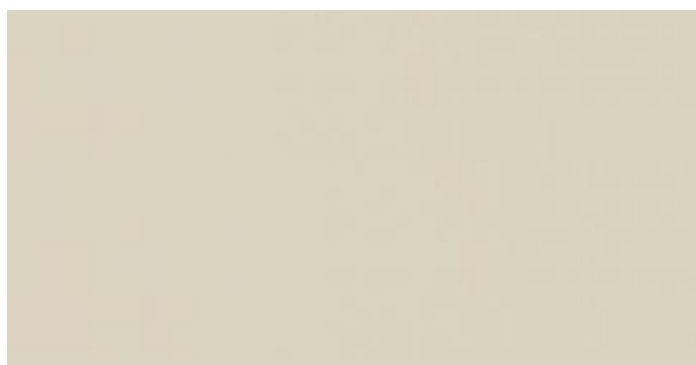

Calm Sea



Eucalyptus



THERMALLY FUSED LAMINATE (TFL) FINISH OPTIONS

TFL cabinet doors and drawers are easy to maintain and will ensure years of use.
Only available in Horizon door style.

TFL OPTIONS



Weekend Getaway



Sheer Beauty



Rhapsody



Sugar Rush



New Wave

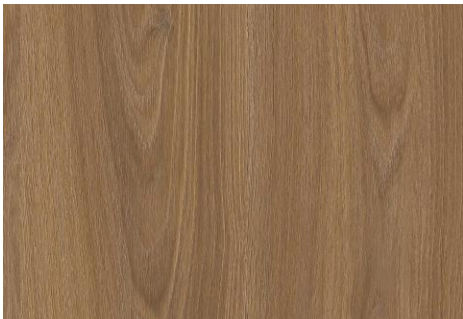

Kiss Curl



Sunday Stroll

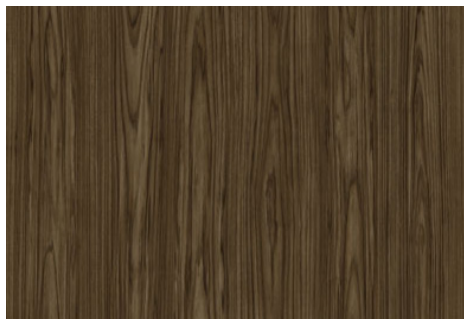

Simply Gallant



Tete a Tete



Night Owl

UPGRADE CABINET STAIN FINISH OPTIONS

Stains are transparent and accent the natural beauty and distinctive grain of your cabinets. Color swatches shown below are for reference purposes only. Colors may vary between wood species. For accurate color representation, please ask your dealer for help ordering a sample door.

STAIN FINISH OPTIONS



Clear Coat
Shown on Oak

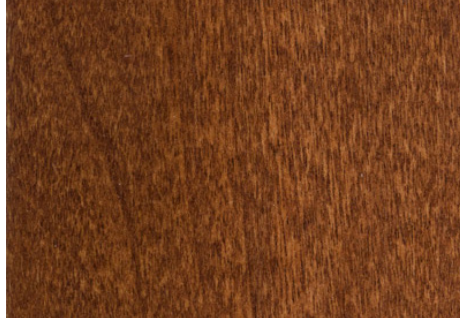

Pecan
Shown on Alder

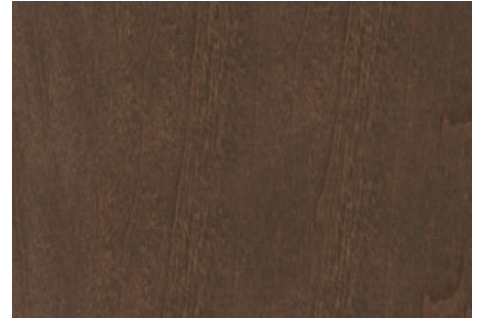

Crimini
Shown on Alder

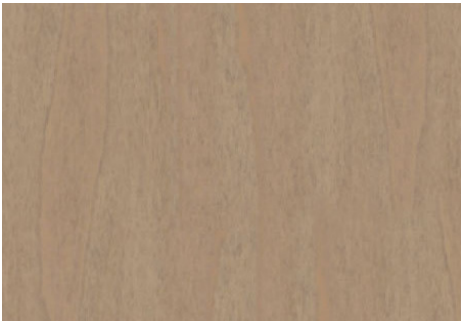

Sycamore
Shown on Alder



Zinc
Shown on Alder



Pinecone
Shown on Alder

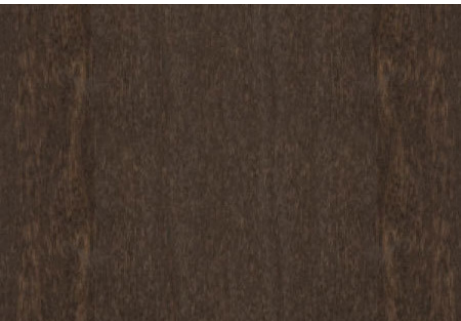

Marmot
Shown on Alder

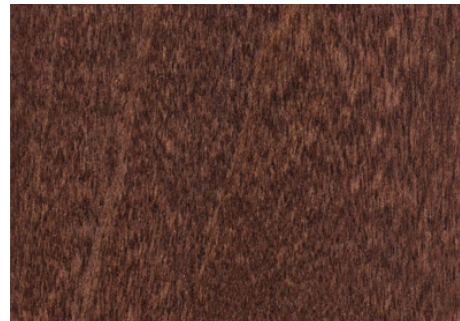

Macchiato
Shown on Alder

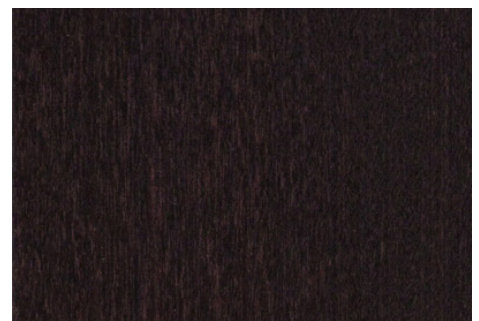

Dark Roast
Shown on Alder

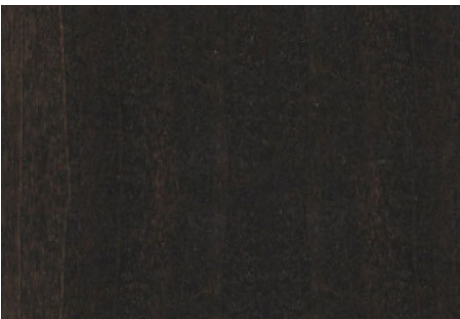

Carbon
Shown on Alder

STANDARD CROWN MOULDING OPTIONS

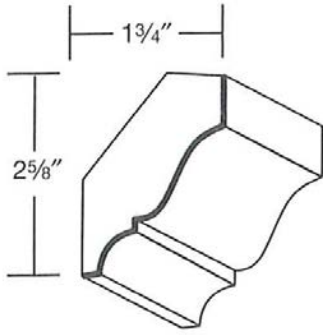

Classic

For Duncan Door Style

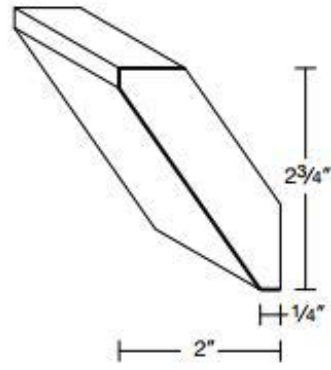

Shaker

For Concord, Parker, Horizon & Jacobsen Door Styles



HARDWARE

HARDWARE HANDLE OPTIONS

Square Handle

Available in 5"

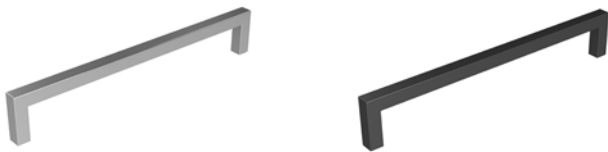

Bar Pull Handle

Available in 6"



Industrial Handle

Available in 6"



Cup Pull

Available in 3"



Top Handle (available on Horizon door style only)

Attaches on the top of door and drawer fronts. Available in 7 3/4"



HARDWARE KNOB OPTION

Tulip Knob

Available in 1"



Satin Nickel



Black



ACCESSORIES



Trash Basket
Available in: 15", 18", 21", 24"



Super Lazy Susan
Available in: 33" or 36" Base Corner
24" Wall Corner



Stem Glass Holder
Available in: 30", 36"



Roll-out Trays
Available in all base cupboard sizes



Base Pull-out Cabinet
Available in: 9", 12"



Wall Pull-out Cabinet
Available in: 9", 12"



Mixer Shelf
Available in: 18", 21", 24" full height base cabinets



Tray Divider
Available in: 9", 12"



Wine Storage Cabinets
Available in: 24", 30"



3 Drawer Base Cabinet
Available in: 12", 15", 18", 21", 24", 27", 30", 33", 36"



Open Shelves
2.5" thick and 10" deep.
Available in: 24", 30", 36", 42", 48", 54" wide.



LED Under-cabinet Lights
Custom Lengths as needed

Choose from our wide variety of cabinet accessories to add style and convenience to your custom kitchen and bathrooms.



VANITY OPTIONS

UPGRADE BATHROOM VANITY OPTIONS

Timberline Vanities are quality, American-made, cabinetry. From the premium double walled, synchronized drawer runners to the solid, soft closing door details, we are excited to offer you our range of contemporary bathroom vanities.

Timberline

CULLEN VANITY



60" Wall Hung Double Bowl in Eucalyptus



48" On Legs in Sheer Beauty

VERA VANITY



48" Wall Hung in Midnight Sun



24" Floor Standing in Chocolate

Vanities are available as wall hung, floor standing or on legs
in 24", 32", 36", 48" Single Bowl or 60" Double Bowl.

Available in Thermally Fused Laminate (TFL) or painted. See pages
73-74 for color options and pages 76-77 for hardware options.



BOOT BENCHES

Boot benches available in all colors, door styles and species shown on pages 72-75 to perfectly match the cabinetry throughout your home.

STYLE OPTIONS

1



Available in 66" and 81"

2



Available in 30", 36", 54" and 60"

3



Available in 30", 36", 54" and 60"

4

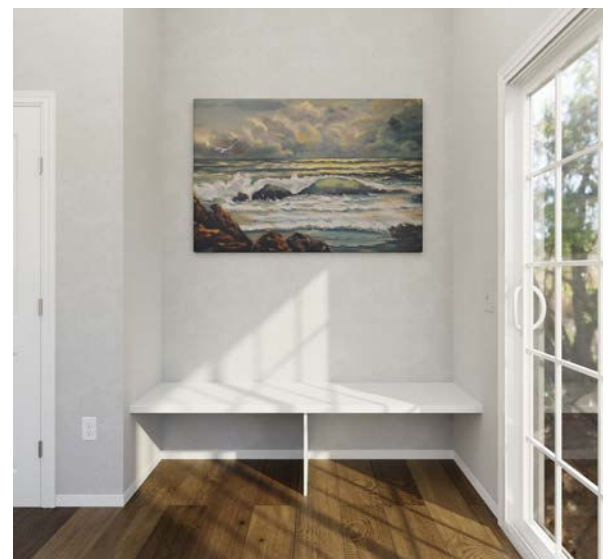

Available in 30" - 90"

5



Available in 54" and 60"

6



Available in 102"





LAMINATE COUNTERTOPS

STANDARD EDGE PROFILE



TEMPO | Soft Curve at Top

UPGRADE EDGE PROFILES



CRESCENT | Soft Curves at Top & Bottom



ORA | 1/8" Radius Full-Wrap Edge
Unavailable in Frosty White



BEVELED | 45° Angle Cut

STANDARD COLOR OPTIONS



Spicewood Springs



Deep Springs



Oiled Soapstone



Rustic Slate



Desert Springs



Bordeaux Juparana



Golden Juparana



Milano Quartz



Pearl Soapstone

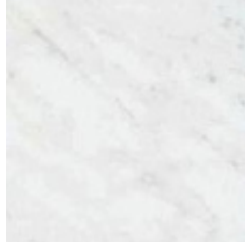

White Carrara



Milano Amber



Milano Brown

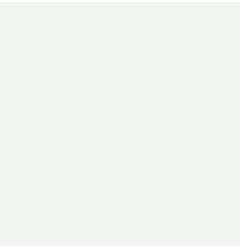

Frosty White



Crimini Walnut

UPGRADE COLOR OPTIONS



Calcutta Marble



Spring Carnival



Italian White Di Pesco



Benjamin Grey



Cafe Di Pesco



Bello Romano



Golden Romano



Madura Gold



Summer Carnival



Bella Noche



Black Alicante

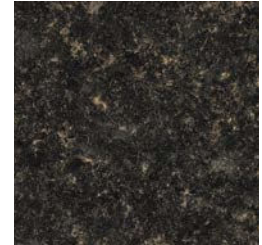

Cosmos Granite

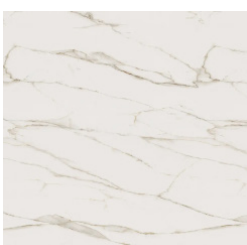

Calacutta Lincoln



Old Mill Oak

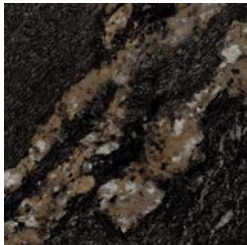

Magnata



Bahia Granite



Ebony Charcoal



Leche Vesta

THINSCAPE COUNTERTOPS

THINSCAPE® Performance Tops are an engineered composite that provides impact, scratch, and moisture resistance, offering next-level durability and performance.



Soluna

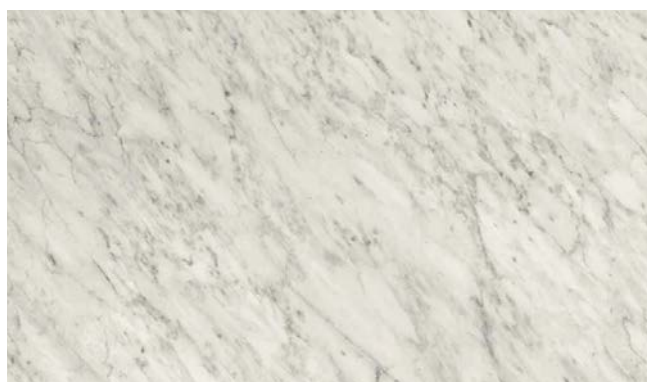

Italian Carrara



Pietra Noir



Calcutta Blanc



Solenne Marble



Tortona Quartzite

1/2" Thickness

EASED EDGE

GRANITE COUNTERTOPS

Granite is an igneous rock, whose by nature composition varies depending on the location from which the rock is quarried. This supports the fact that granite is available in almost a limitless variety of colors, textures, and patterns, which is why no two patterns are the same.. If you're in search of a gorgeous, resilient stone, granite may be your answer.



Colonial Gold



Mayfair White



Steel Grey

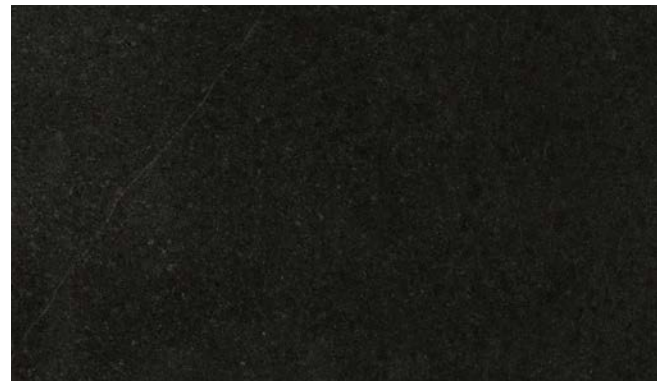

Massabi Black



Thunder Bay



Athena White

3 cm Thickness

EASED EDGE

QUARTZ COUNTERTOPS

This highly rated surface offers unique patterns and uniform color and patterning. Quartz surfaces are man made of 85%-95% crushed quartz with a resin binder. They are highly scratch resistant, non-porous and very resistant to bacteria. Quartz is an upgrade countertop and you can visit our website or dealers to view colors and edge profiles available.



Copper Lake



Golden Leyra



Neu Calacatta



Montecavallo



Kastelle

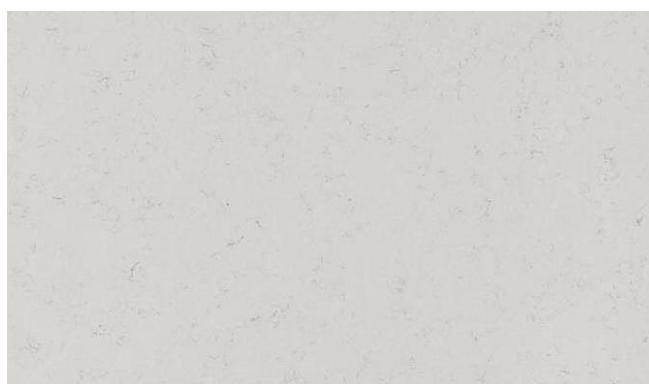

Luenza

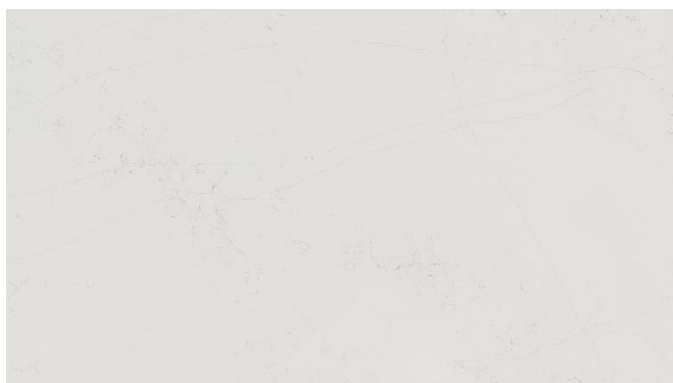

Altena



EASED EDGE



CULTURED MARBLE VANITY TOPS

CULTURED MARBLE VANITY TOPS

Cultured marble is a blend of stone particles and resins that are combined with pigments to produce a natural looking match to a marble or solid surface look. The sink bowl is integrated seamlessly with the countertop and comes in one piece.

STANDARD COLOR

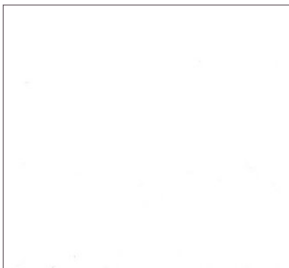

Snow

BOWL PROFILE



Wave Bowl Profile

Vanity Cabinets can be Floor Standing or Wall Hung

UPGRADE COLORS

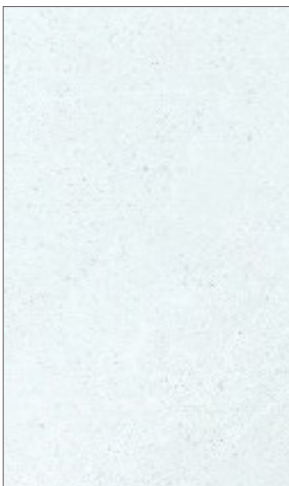

White on White



Ice Gray



Grecian



Glacier



SINKS

STANDARD



KITCHEN
Stainless Steel Dual Mount Sink
Single Bowl - 9" Deep



BATHROOM
Integrated One-piece Top
(see page 88)



LAUNDRY
Stainless Steel Top Mount Sink
Single Bowl
Min Cabinet Width is 30"

UPGRADE KITCHEN SINK OPTIONS



KITCHEN

Stainless Steel Under Mount Sink
Single or Double Bowl - 8 1/2" Deep



KITCHEN

Karran Sink Top Mount Double
Equal Bowl Quartz in White or
Black - 9" Deep



KITCHEN

Karran Sink Top Mount Large
Single Bowl Quartz in Black or
White - 9" Deep



KITCHEN

Stainless Steel Top Mount Farm Sink
Double Bowl - 9" Deep



KITCHEN

Stainless Steel Top Mount Farm Sink
Single Bowl - 9" Deep

UPGRADE SINK OPTIONS



LAUNDRY

White Acrylic Top Mount Sink
Single Bowl - 13" Deep or 9" Deep
*13" deep has min cabinet width of 24" or
9" deep has min cabinet width of 15"*
(Not available on Quartz or Granite tops)



BAR

Stainless Steel Top Mount Sink
Single Bowl - 6" Deep
Min Cabinet Width is 21"

UPGRADE BATHROOM SINK OPTIONS



BATHROOM
Mansfield West Hampton
Pedestal Sink - 33 1/2" Tall



BATHROOM
Wall-Mount, China Single Bowl Sink
ADA Accessible



BATHROOM
Mansfield China Top Mount Sink
Single Bowl



BATHROOM
Undermount Sink for Granite or
Quartz, Single Bowl
5.5" Deep



RECTANGLE*
Ceramic Sink Collection
19 1/2" x 15 1/2" x 4 1/4"



ROUND**
Ceramic Sink Collection
15" x 15" x 5 1/4"



SQUARE**
Ceramic Sink Collection
17 1/2" x 14 3/4" x 4 1/8"



*Rectangle includes tap landing.

**Wall mount faucet required.



FAUCETS

STANDARD CHROME



LAUNDRY



KITCHEN



BATH
Vanity



TUB/SHOWER



SHOWER
Handheld



SHOWER
Rainhead

UPGRADE OPTIONS IN CHROME



VANITY
Wall Mount Faucet



BATH
Clawfoot Tub Faucet



UPGRADE OPTIONS IN SATIN NICKEL



KITCHEN/LAUNDRY



KITCHEN
Pot filler



TUB/SHOWER



BATH
Vanity



BATH
Clawfoot Tub Faucet



SHOWER
Handheld



BATH
Wall Mount Faucet



BATH
Roman Tub Faucet



SHOWER
Rainhead



UPGRADE OPTIONS IN BLACK



KITCHEN



KITCHEN/LAUNDRY



KITCHEN
Pot filler



BATH
Roman Tub Faucet



BATH
Vanity



BATH
Wall Mount Faucet



SHOWER
Handheld



SHOWER
Rainhead



TUB/SHOWER



BATH ACCESSORIES

UPGRADE SHOWER RODS



Straight Shower Rod
Satin Nickel or Black



Curved Shower Rod
Satin Nickel or Black

UPGRADE GRAB BARS



Available in 18", 36", 42"
Satin Nickel or Black
Note: ADA Options available upon request.

STANDARD MIRROR



Standard - Beveled Edge
24x32 or 24x36

UPGRADE MIRRORS



Rectangle Framed Nickel
34-1/16" x 22-1/16"



Rectangle Framed Black
34-1/16" x 22-1/16"



Round Framed Nickel
28-1/8" x 28-1/8"



Round Framed Black
28-1/8" x 28-1/8"



Upgrade - Wood Framed
24"x36"
Stained/Painted to Match Vanity
Not Available in TFL options

UPGRADE MİRRORED CABINETS



Willow Mirrored Cabinet
Available in 24", 32", 36", 48", 60"



Sage Mirrored Cabinet
Available in 24", 32", 36", 48", 60"



Isla Mirrored Cabinet
Available in 32", 36", 48", 60"

Mirrored cabinets require an LED light situated above the vanity, which replaces the wall-mounted vanity light.

UPGRADE TOPPER



Toilet Topper



UPGRADE SKYLINE SATIN NICKEL PACKAGE*



Towel Bar



Towel Ring



Paper Holder



Robe Hook

UPGRADE SKYLINE BLACK PACKAGE*



Towel Bar



Towel Ring



Paper Holder



Robe Hook

UPGRADE DOLORES PARK SATIN NICKEL PACKAGE*



Towel Bar



Towel Ring



Paper Holder



Robe Hook

UPGRADE DOLORES PARK BLACK PACKAGE*



Towel Bar



Towel Ring



Paper Holder



Robe Hook

*All bathroom accessory packages ship loose for on site installation.

BATHROOM FIXTURES

STANDARD TUB/SHOWER UNITS



36", 48", 60" Fiberglass Shower Units
Optional seat shown (48" and 60" only,
Left or Right Hand Plumbing available)



60" Wide Fiberglass Tub/Shower Unit
Left or right hand plumbing available.

UPGRADE SHOWER UNITS



ADA Shower Unit
62"W x 37" D x 78 7/8" H

Includes:

- 3/4" threshold
- Stainless Steel Grab Bars
- Fold up Seat
- Hand-held shower with 24" Slide bar

SaloTM
Mfg. Inc.

UPGRADE TUB OPTIONS



Contemporary Free Standing Tub 28" H x 66" L x 20" D



Clawfoot Free Standing Tub 30"W x 60"L
Feet available in Chrome or Satin Nickel



Rectangle Drop-In Tub 36"W x 72"L
Available as a soaker or whirlpool. Optional Heater Kit Includes Cabinetry Surround.



Corner Drop-In Tub 60" or 54" Option
Available as a soaker or whirlpool. Optional Heater Kit



UPGRADE TILE SHOWER OPTIONS

Choose from a fiberglass or a tile base. Tile options are on pages 64-67. Shower screens come in Satin Nickel or Black. Custom frameless glass panels available upon request.



Corner
Fiberglass or Tile base
Shower Door recommended
Sizes: 36"x 36", 42"x 42"



NEO Corner
Fiberglass or Tile base
Shower Door recommended
Size: 38"x 38"



3 Sided
Fiberglass or Tile base
Sizes: 48"x 36", 60"x 36", 72"x 36", 72"x 48"
(Tile base can be custom size)

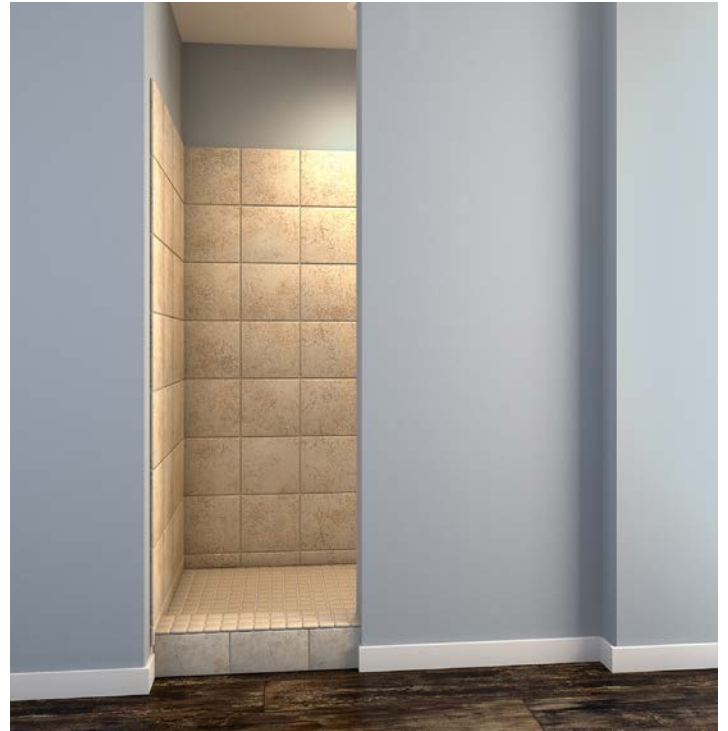

Walk In
Fiberglass or Tile base
Sizes: Small, Medium, or Large
(Tile base can be custom size)

UPGRADE TILE SHOWER OPTION



1/2 Wall Glass
Fiberglass or Tile base
Sizes: Small, Medium, or Large
(Tile base can be custom size)

Corner Shelves
Available in all tile showers or tubs with tiled surrounds
• 7-11/16"
• Stainless or Black

TOILETS



Standard
Seat Height: 16 1/2"H

UPGRADE SHOWER INSERT OPTIONS



Corner Seat
Available in all tile showers



Bench Seat
Available in Walk In and 1/2 wall glass showers



Recessed Niche
Available in all tile showers or tubs with tiled surrounds
• 12x12"
• 12x48"

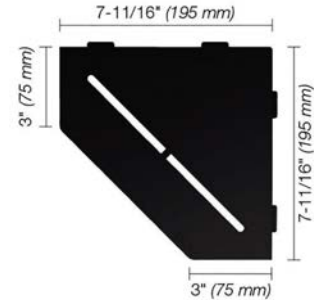
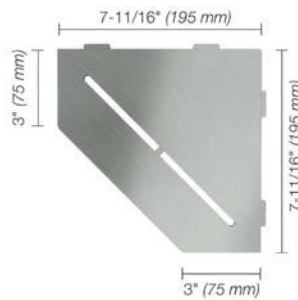

Upgrade - Tall Elongated
Seat Height: 17 5/8"H





LIGHTING

STANDARD LIGHTING



12" LED Surface Mount Light



Carson Vanity Light Nickel



6" LED Downlight White
(STD for Kitchen Sinks, Pantry,
Tub and/or Shower Units)

We know the perfect lighting is essential to your home design.

That's why we have the **'omit fixture option'**. If you have a special light fixture or ceiling fan in mind that you don't see here, just let us know and we'll prep your space for on-site installation of the fixture(s) that best fit your style.

UPGRADE SATIN NICKEL OPTIONS



Joni Pendant
Clear Glass



Carson Pendant Nickel
Seeded Glass



Toni Pendant
Frosted Glass



Carli Chandelier Nickel



Joni Chandelier Nickel
Clear Glass



Toni 3-Light Pendant
Frosted Glass



Cain Vanity 3-Light Nickel
Clear Glass



Joni 3-Light Pendant
Clear Glass



Opal Glass Wall Light
Frosted Glass



UPGRADE BLACK PACKAGE



12" LED Surface Mount Light



Carson Vanity Light Black
Seeded Glass



6" LED Downlight White
(STD for Kitchen Sinks, Pantry,
Tub and/or Shower Units)

We know the perfect lighting is essential to your home design.

That's why we have the **'omit fixture option'**. If you have a special light fixture or ceiling fan in mind that you don't see here, just let us know and we'll prep your space for on-site installation of the fixture(s) that best fit your style.

UPGRADE ADDITIONAL BLACK OPTIONS



Portia Pendant Black
Frosted Glass



Carson Pendant Black
Seeded Glass



Cain Pendant Black
Clear Glass



Brielle Chandelier Black



Joni Chandelier Black



Moss Chandelier



Joni Vanity Light



Cain Vanity 3-Light Black
Clear Glass



Cain Sconce
Clear Glass

UPGRADE CEILING FANS



52" LED Ceiling Fan Satin Nickel
5DIC52BSD-V1

Blade Finish Options:
Silver & American Walnut



52" LED Ceiling Fan Black
5DIC52BKD-V1

Blade Finish Options:
Roman Bronze

STANDARD EXTERIOR LIGHT



Dawn Outdoor Light Black
4 3/8 IN W x 7.5 IN H

UPGRADE EXTERIOR LIGHTS



Jory Outdoor Light Black
4 1/4" W x 9" H



MotionSense
Outdoor Light
W: 12" H: 7 1/4"



We know the perfect lighting is essential to your home design.

That's why we have the **'omit fixture option'**. If you have a special light fixture or ceiling fan in mind that you don't see here, just let us know and we'll prep your space for on-site installation of the fixture(s) that best fit your style.



ELECTRICAL

STANDARD INTERIOR SWITCHES & OUTLETS



Rocker Switch



Outlet

UPGRADE SWITCH & OUTLET OPTIONS



Dimmer Switch



Motion Light Sensor



Recessed Media Box



USB Charging Outlet



Light Up Outlet



FIREPLACES

MANTLE OPTIONS



Barnwood Shelf
48"W x 4"H x 8"D



Traditional Shelf
(MDF or Oak/Stain or paint) 42"W



1/2 Pine Log
48"W
Note: Characteristics such as Knots and splits may vary in the pine log mantel and is not considered warranty defects.



Battlefield
(Painted MDF, Stained Maple or Distressed Knotty Alder) 75"W x 54"H x 9"D
This mantel cannot be used with a wood burning fireplace.

ADDITIONAL OPTIONS



Adjustable TV Mount
Pulls out to 16.6" and retracts to 2.5" 100lb max
42"-84" screens, Tilts the TV 5° up and 15° down

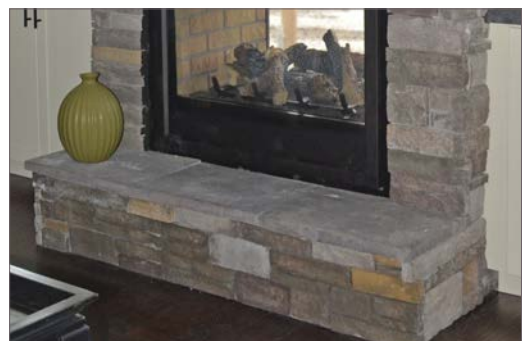

Hearthstone
A raised stone hearth in grey.
12" deep, and 12" high

STONE SURROUND OPTIONS



Colonial Gold



Mayfair White



Steel Grey



Thunder Bay

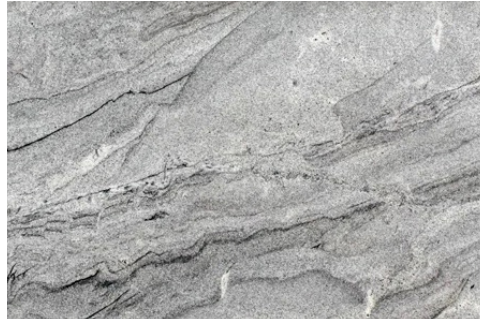

Athena White



Massabi Black

EVOLVE STONE OPTIONS



Dune Point



Kodiak Mine



Winter Valley



Morning Aspen



Phantom Shadow

VERSETTA STONE OPTIONS



Mission Point



Plum Creek



Sterling

ELECTRIC FIREPLACE OPTIONS



HEAT & GLO SIMPLIFIRE

Electric Fireplace

- 100% efficient, adjustable heat that costs just pennies an hour to operate
- Enjoy the ambiance with or without heat
- Never replace bulbs thanks to LED flame technology
- Intuitive, multifunction remote for control at your fingertips
- Zone heat your space to remain comfortable, while reducing your monthly bills

ALLUSION PLATINUM

Electric Fireplace



The Allusion Platinum Fireplace can make your home a unique reflection of you with a dazzling upscale linear electric fireplace. From a large viewing area with minimal frame

- 51" wide and 19-1/2" high, 4 flame color choices, 13 ember bed color choices for complete customization
- Enjoy year-round with or without the heat
- Provides a clean look that is fully recessed on a finished 2 x 6 wall
- Mounted 16" from Floor (Bottom of Fireplace)

SIMPLIFIRE ALLUSION

Electric Fireplace



The Allusion electric fireplace series embraces modern design by combining linear proportions with a multitude of flame and LED ember bed lighting themes. Additionally, intuitive operations exemplified by the standard remote and touch controls on the fireplace front.

- 48" wide and 20" high, 4 flame color choices, 14 ember bed color choices for complete customization
- Enjoy the ambiance with or without heat
- 100% efficient LED technology with adjustable heat
- Mounted 16" from floor (to bottom of fireplace)

GAS FIREPLACE OPTIONS



HEATILATOR MDV3732 DIRECT VENT

Gas Fireplace

- Standard blower and remote control provide efficiency and convenience
- Adjustable flame height allows you to control heat output. In case of a power failure, standard IntelliFire™ ignition with battery back-up will continue to operate
- Standard ANSI-compliant firescreen eliminates glass glare and provides a measure of protection from accidental contact
- Multi-function remote control

WOOD FIREPLACE OPTIONS



HEATILATOR AC36

Wood Fireplace

The Accelerator features meticulous craftsmanship for robust fires and an impressive appearance. Multiple doors and traditional or herringbone brick panels add individual style to the Accelerator's valued performance.

- 36" viewing area.
- Radiant or heat-circulating options
- Available with 1/2 log, barnwood, or traditional shelf mantles only.

HEATILATOR CONSTITUTION

Wood Fireplace

Enjoy intense, efficient fires in any environment. This wood-burning powerhouse exceeds the strictest environmental standards in the nation. Proven technology delivers precision start-up and air control for clean, consistent burns and extended performance. Relax and let the Constitution blaze.

- EPA Phase II Compliant
- Heats 1,000 - 2,600 sq.ft. of space with up to 10 hours burn time from each load of wood
- Choose either the Mantle option or the TV mount; space constraints prohibit both.
- 12" Hearth is required





APPLIANCES

Through ingenuity and innovation, GE appliances answer real-life needs, define trends, simplify routines and upgrade the look and feel of the living space. Next generation features are solving real-life needs. With a forward-thinking tradition that spans over 100 years, today's GE appliances sync perfectly with the modern lifestyle.

Contact us for a price quote on a color if it is not pictured.





GE Appliances offers kitchens that perfectly complement modern finishes, materials and colors. Backed by more than 100 years of purposeful innovations, owners can expect style, lasting quality and features that improve their everyday lives.

GE STAINLESS APPLIANCE PACKAGE



Over the Range Microwave 1.6 cu ft, 300 cfm, 950 watt, Recirculating Venting JNM3163



30" Free-Standing Electric Range, Glass Cooktop, Self Clean GRF400



Refrigerator 25.3 cu ft, Side-by-Side, Ice & Water GSE25



Dishwasher 4 Cycle GDF511

GE STAINLESS À LA CARTE OPTIONS



Over the Range Microwave 2.1 cu ft, 400 cfm, 1000 watt, vented PVM9215



30" Free-Standing Gas Range, Self-Clean JGB635



Refrigerator 25.8 cu ft. French Door Bottom Freezer, Ice & Water GFE26



Dishwasher 4 Cycle GDF511



Cabinet Mount Vent Hood 30", 2 Speed Fan Control & Light, Non-Vented JVX3300



Gas Cooktop with 5 Burners 30" JGP5030
Stainless or Black Finish Only



GE® 36" Built-In Knob Control Electric Cooktop JP3036



GE® 30" Smart Built-In Self-Clean Convection Single Wall Oven JTS5000



GE Profile provides homeowners modern design and the latest features in home appliances. Designed for today's smart home, GE Profile provides features that allow you to do more, through remote monitoring, voice activation and technology that takes the guesswork out of cooking and cleaning.

PROFILE STAINLESS APPLIANCE PACKAGE



GE Profile™ 2.1 Cu. Ft. Over-the-Range Sensor Microwave Oven
PVM9005



GE Profile™ 30" Smart Slide-In Electric Convection Range
PSS93



GE Profile™ 27.7 Cu. Ft. French-Door Refrigerator
PFE28



GE Profile™ Top Control Dishwasher with Sanitize Cycle
PDT715



PROFILE STAINLESS À LA CARTE OPTIONS



GE Profile™ 1.5 Cu. Ft. Countertop Convection/Microwave Oven with Trim Kit PEB9159



GE Profile™ 30" Smart Slide-In Front-Control Gas Range PGS930



GE Profile™ 22.1 Cu. Ft. Counter-Depth French-Door Refrigerator PYE22



GE Profile™ Top Control Dishwasher with Sanitize Cycle & Dry Boost PDT715



GE Profile™ 30" Smart Designer Wall Mount Hood UVW9301



GE Profile™ 30" Built-In Touch Control Electric Cooktop PEP9030



GE Profile™ 36" Built-In Touch Control Induction Cooktop PHD9036



GE Profile™ 30" Smart Built-In Convection Double Wall Oven PTD7000

PROFILE BEVERAGE OPTIONS



GE Profile™ Series Beverage Center PVS06
Stainless finish only

CAFÉ

DISTINCT BY DESIGN™



Choosing a major appliance to fit your style and needs doesn't have to be overwhelming. Upgrade your cooking space with our luxury kitchen appliances. Elevate your cooking game by investing in high-end kitchen appliances that meet professional cooking standards. Discover our range of Café major kitchen appliances, from elegant ovens and refrigerators to modern microwaves and understated cooktops.

CAFÉ STAINLESS APPLIANCE PACKAGE



Café™ 23.1 Cu. Ft. Smart Counter-Depth French-Door Refrigerator
CWE23SP2



Café™ 1.7 Cu. Ft. Convection Over-the-Range Microwave Oven
CVM517P2



Café™ 30" Smart Slide-In, Front-Control, Radiant and Convection Range
CES700P2



Café™ Dishwasher with Sanitize and Ultra Wash & Dry
CDT845P2

CAFÉ STAINLESS À LA CARTE OPTIONS



Café™ 30" Smart Slide-In, Front-Control, Gas Range with Convection Oven
CGS700P2



Café™ 30" Smart Built-In Convection Double Wall Oven
CTD90DP2



Café™ 36" Smart All-Gas Commercial-Style Range with 6 Burners (Natural Gas)
CGY366P2TS1



Café™ Professional Series 30" Smart Built-In Convection Single Wall Oven
CTS90DP2



Café™ 27.7 Cu. Ft. Smart French-Door Refrigerator with Hot Water Dispenser
CFE28TP2MS1



Café™ 27.8 Cu. Ft. Smart 4 French-Door Refrigerator
CVE28DP2



Café™ 30" Wall-Mount Glass Hood
CVW73012



Café™ 36" Commercial-Style Hood
UVW93642



Café™ 36in Gas Cooktop
CGP70362
(stainless only, 30" available)



Café™ 30in Touch-Control Electric Cooktop Black
CEP90302
(also available in black & 36")



Café™ 1.5 Cu. Ft. Smart Countertop Convection Microwave Oven
CEB515P2



Café™ Built-In Microwave Drawer Oven
CWL112P2

CAFÉ

DISTINCT BY DESIGN™



Choosing a major appliance to fit your style and needs doesn't have to be overwhelming. Upgrade your cooking space with our luxury kitchen appliances. Elevate your cooking game by investing in high-end kitchen appliances that meet professional cooking standards. Discover our range of Café major kitchen appliances, from elegant ovens and refrigerators to modern microwaves and understated cooktops.

CAFÉ BLACK APPLIANCE PACKAGE



Café™ 23.1 Cu. Ft. Smart Counter-Depth French-Door Refrigerator
CWE23SP3



Café™ 1.7 Cu. Ft. Convection Over-the-Range Microwave Oven
CVM517P3



Café™ 30" Smart Slide-In, Front-Control, Radiant and Convection Range
CES700P3



Café™ Dishwasher with Sanitize and Ultra Wash & Dry
CDT845P3

CAFÉ BLACK À LA CARTE OPTIONS



Café™ 30" Smart Slide-In, Front-Control, Gas Range with Convection Oven
CGS700P3



Café™ 30" Smart Built-In Convection Double Wall Oven
CTD90DP3



Café™ 36" Smart All-Gas Commercial-Style Range with 6 Burners (Natural Gas)
CGY366P3



Café™ Professional Series 30" Smart Built-In Convection Single Wall Oven
CTS90DP3



Café™ 27.7 Cu. Ft. Smart French-Door Refrigerator with Hot Water Dispenser
CFE28TP3



Café™ 27.8 Cu. Ft. Smart 4 French-Door Refrigerator with Hot Water Dispenser
CVE28DP3



Café™ 30" Wall-Mount Glass Hood
CVW73013



Café™ 36" Commercial-Style Hood
CVW93643



Café™ 36in Gas Cooktop
CGP70362
(stainless only, 30" available)



Café™ 30in Touch-Control Electric Cooktop Black
CEP90301
(also available in stainless & 36")



Café™ 1.5 Cu. Ft. Smart Countertop Convection Microwave Oven
CEB515P3



Café™ Built-In Microwave Drawer Oven
CWL112P3

CAFÉ

DISTINCT BY DESIGN™



Choosing a major appliance to fit your style and needs doesn't have to be overwhelming. Upgrade your cooking space with our luxury kitchen appliances. Elevate your cooking game by investing in high-end kitchen appliances that meet professional cooking standards. Discover our range of Café major kitchen appliances, from elegant ovens and refrigerators to modern microwaves and understated cooktops.

CAFÉ WHITE APPLIANCE PACKAGE



Café™ 23.1 Cu. Ft. Smart Counter-Depth French-Door Refrigerator
CWE23SP4



Café™ 1.7 Cu. Ft. Convection Over-the-Range Microwave Oven
CVM517P4



Café™ 30" Smart Slide-In, Front-Control, Radiant and Convection Range
CES700P4

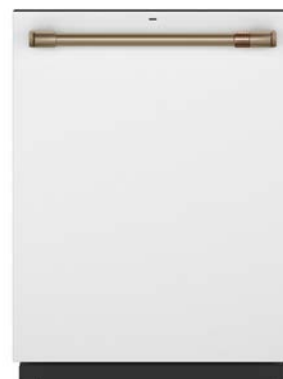

Café™ Dishwasher with Sanitize and Ultra Wash & Dry
CDT845P4

CAFÉ WHITE À LA CARTE OPTIONS



Café™ 30" Smart Slide-In, Front-Control, Gas Range with Convection Oven
CGS700P4



Café™ 30" Smart Built-In Convection Double Wall Oven
CTD90DP4



Café™ 36" Smart All-Gas Commercial-Style Range with 6 Burners (Natural Gas)
CGY366P4



Café™ Professional Series 30" Smart Built-In Convection Single Wall Oven
CTS90DP4



Café™ 27.7 Cu. Ft. Smart French-Door Refrigerator with Hot Water Dispenser
CFE28TP4



Café™ 27.8 Cu. Ft. Smart 4 French-Door Refrigerator with Hot Water Dispenser
CVE28DP4



Café™ 30" Wall-Mount Glass Hood
CVW73014



Café™ 36" Commercial-Style Hood
CVW93644



Café™ 36in Gas Cooktop
CGP70362
(stainless only, 30" available)



Café™ 30in Touch-Control Electric Cooktop Black
CEP90301T
(also available in stainless & 36")



Café™ 1.5 Cu. Ft. Smart Countertop Convection Microwave Oven
CEB515P4



Café™ Built-In Microwave Drawer Oven
CWL112P4

Haier

Haier small-size appliances let you live large even in the smallest kitchen. Integrated handles, unique configurations, built-ins and free-standing appliances – our smaller appliances are designed for function, fashion and easy installation. Whether you've got an urban apartment or condo, tiny kitchen, man cave, home bar, or even an RV, we've got small-size appliances to maximize space with style to spare.

HAIER STAINLESS SMALL SPACE OPTIONS



24" 1.4 Cu. Ft. Over-The-Range Microwave Oven
HMV1472



24" 2.9 Cu. Ft. Electric Range
QAS740



14.5 Cu. Ft. 4 Door Refrigerator
QJS15



18" Stainless Steel Interior Dishwasher QDT125



From stackable, standalone or all-in-one, choose to furnish your home with appliances from GE and have your home equipped for laundry right away.

LAUNDRY OPTIONS



GE Unitized Spacemaker® 3.8 cu. ft. Capacity Washer with Stainless Steel Basket and 5.9 cu. ft. Capacity Gas Dryer
GUD27



GE® 7.8 cu. ft. Smart Front Load Electric Dryer with Steam and Sanitize Cycle
GFD65

GE 5.0 cu. ft. Smart Front Load Washer with OdorBlock UltraFresh Vent System
GFW655

**2-IN-1
WASHER/DRYER**



GE Profile - UltraFast 4.8 cu ft Large Capacity All-in-One Washer/Dryer Combo with Ventless Heat Pump Technology - Carbon Graphite
PFQ97



GE Profile™ 5.4 cu. ft. Capacity Washer with Smarter Wash Technology and FlexDispense™
PTW900



GE Profile™ 7.3 cu. ft. Capacity Smart Electric Dryer with Fabric Refresh
PTD90

Note: Gas available on dryer options.



WATER HEATERS & HVAC

CHAMPION® FURNACE PACKAGES

Each package is individually engineered to suit your custom home. Champion systems are a great product and backed by some of the best warranties in the business. Just let your dealer know that you would like a furnace system installed and Northstar will handle it from there. We even go as far as checking the elevation of your home and adding a high altitude pressure switch if needed!



THERMOSTATS



STANDARD
Low Voltage, Programmable Thermostat

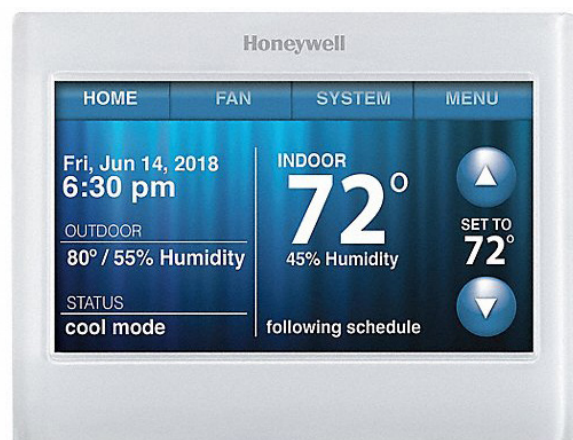

UPGRADE
Wi-Fi Touch Screen Programmable Thermostat

AO SMITH® WATER HEATERS

ProMax® is an economical water heater designed for households that need an exceptional performer and provides long-lasting value. All ProMax® water heaters have a six year limited tank and parts warranty.



ELECTRIC

Available in:
 ENS-40 - 40 Gallon
 ENS-50 - 50 Gallon
 LTE-80 - 80 Gallon



NATURAL GAS | LP

Available in:
 GCRL-40 - 40 Gallon
 GCRL-50 - 50 Gallon
 GCRL-75 - 75 Gallon



ELECTRIC

R4LA 240E-Tankless



Natural Gas | LP

ATI 240H-N-Tankless



Panasonic Energy Recovery Ventilator (ERV)

FV-04VE1



COMFORT OPTIONS

UPGRADED INSULATION



R-60 Attic Insulation
(Where Applicable)



R-11 Insulation to all
Internal Walls



Additional R-6 Insultex House
Wrap Insulation on Walls (R-21
standard)

These options are for the homeowner who wants a little **warmth coupled with costs savings**. The additional insulation in the walls as well as the overall R value provide a noise barrier and **coziness unparalleled** throughout the home, especially in cooler, damp climates when your home is covered by a blanket of snow! Choose this option to **reduce drafts and increase energy efficiency**. These options aren't as much seen as it is felt – but it will pay off for the years to come!





STANDARD SPECIFICATIONS

CODES

All homes are built to meet or exceed the following codes:

- International Residential Code
- Uniform Plumbing Code
- Uniform Mechanical Code
- National Electric Code
- State Energy Code
- State Building Code

FLOOR SYSTEM

- 2 x 10 Joists at 16" on center for up to 14'6" wide
- 2 x 12 Joists at 16" on center for up to 16'6" wide
- Double Rim Joists on outside edges
- Triple Center Rim Joists with joist hangers
- Thermax Insulated Rim Boards for continuous insulation
- End Floor Bridging – Floor Supports for added strength
- 3/4" Tongue and Groove OSB Sub-Flooring (Glued and Nailed)

ROOF SYSTEM

- 60# or 40# Load Engineered Trusses at 24" on center
- Timberline Architectural Asphalt Shingle
- 30# Synthetic Underlayment
- 7/16" OSB Exterior Sheathing
- 16" Overhang with 2 x 6 Sub-Fascia
- EDCO Metal Soffit & Fascia
- Ice Dam Protection (ice and water shield), 6' up roof
- Steel Roof Drip Edge
- 5/8" Sheetrock on ceiling - adhered with 2-part foam spray glue to increase strength and minimize possible cracking
- Fold-up end gable trusses with building wrap

WALL SYSTEMS

Exterior

- 2 x 6 studs at 16" on center with 2 x 6 double top plate
- 1/2" gypsum board on walls screwed and glued
- 1/8" Brace board on interior side of longitudinal walls and mating walls, stapled and glued
- 7/16" OSB exterior sheathing for added strength
- Continuous sill seal for increased insulation
- Double 2 x 10 headers over openings
- Intersecting interior walls secured with lag screws
- Drywall on mating wall screwed and glued
- 8' flat ceiling height

Interior

- 2 x 4 Studs at 16" on center
- 2 x 6 Studs at 16" on center for plumbing wall only
- 1/2" Gypsum Board, Screwed as per code requirements

INSULATION

- Walls - R-21
- Roof - R-50 (R-49 to Vaulted areas)
- Rim - R-21
- Batt Insulation at Energy Heel of Truss
- All penetrations in exterior and mod line walls sealed

Request a copy of our **Platinum Series Plans Book** to view our vast array of plans!



PLUMBING & HEATING

- Pex water supply lines with shut off valves run to central location on bottom of joists
- PVC Drain, Waste and Vent Piping stubbed through floor for onsite connection
- Radon Venting installed through walls, to be connected on site
- 8" Deep Stainless Steel Sink in Kitchen
- Moen Single Lever Faucets throughout
- One Piece Fiberglass Tub/Shower Unit
- HVAC boots and registers installed per code
- China Lavatory 1.6 Gallon Water Efficient Toilets
- Ice maker box behind refrigerator/Dryer vent box behind dryer
- Re-vent pipe to all basement homes
- Exterior Frost Free faucet installed at kitchen location



ELECTRICAL

- 200 Amp, 40 Space, Electrical Service panel
- Modern Cordless Door Chime at front door
- TV/Phone jacks strategically placed in five locations throughout the home, rough-in only with pull wires
- Exterior GFCI Outlet
- All boxes mounted to studs
- Smoke and Carbon Dioxide Detectors per code
- Bath fan with LED Light, 80 CFM 1.5 Sones, Energy Star Certified
- LED down light over tub/shower and kitchen sink

INTERIOR FINISHES

- Pre-finished painted base and casing add the perfect finishing touch
- Walls and ceilings coated with an orange peel finish
- Bullnose Drywall corners
- Vapor barrier latex primer/finish, sprayed and rolled
- Plate glass beveled edge vanity mirrors



WINDOWS, DOORS & CLADDING

- Low E Double hung windows built to meet Energy Star® standards for superior performance
- Double 4 Vinyl Siding .042" thickness
- Premium Select Steel 2 Panel insulated Entrance door, primed white with a smooth surface ideal for painting
- Bayerbuilt solid interior doors pre-finished using a water-based stain with a water-based UV seal and top coat for a durable finish
- Durable Satin Nickel door hardware - keyed knob provided at entrance door, privacy knobs provided for all bedrooms and bathrooms. Entrance doors keyed alike. Dead bolts provided for one exterior door



FLOOR COVERINGS

- 40oz Plush Shaw Carpeting on 8lb pad in living room, hallways and bedrooms
- All carpeted areas finished with a rolled edge
- Congoleum LuxFlor Vinyl Flooring in kitchen, dining room, bathrooms, foyer, and laundry as indicated on plans



CABINETS & COUNTERTOPS

- Timberline Full Access cabinetry throughout
- Full Overlay door design
- Drawer System - Double sided metal box full extension soft close hardware
- Soft Close Doors
- Crown Moulding on all upper cabinetry (excluding TFL/Solid Matte Finishes)
- Cabinetry Hardware
- High Definition Laminate Countertop with Tempo edge pre-formed 3" Backsplash

CLOSETS

- Bedrooms - one level of wood shelving, with built-in hanging rail
- Linen - three levels of wood shelving
- Pantry - five levels of wood shelving

Visit our [website](http://www.northstarsb.com) for more information and all warranty details!

www.northstarsb.com



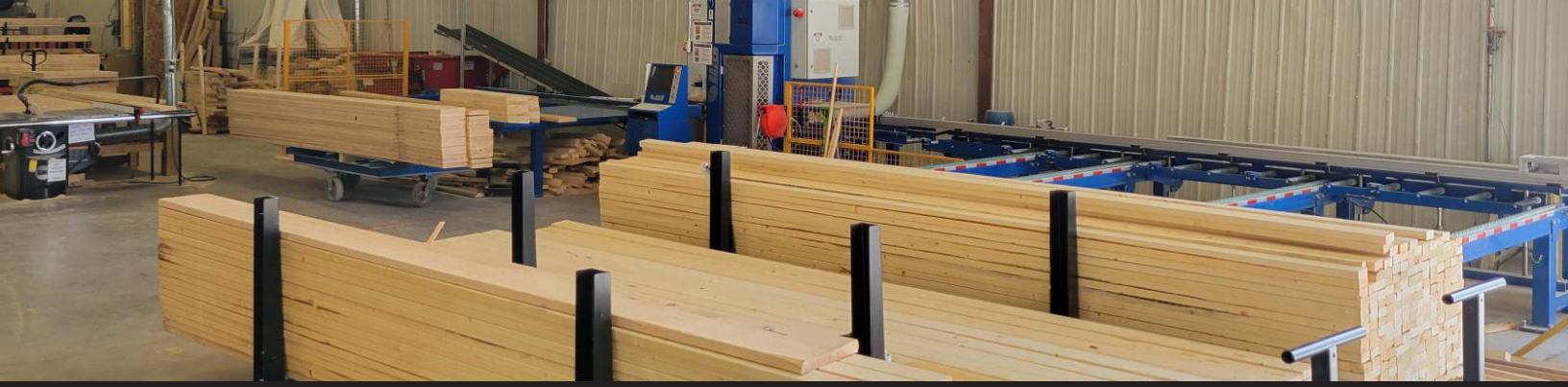

CONSTRUCTION DETAILS

WALL HEIGHTS

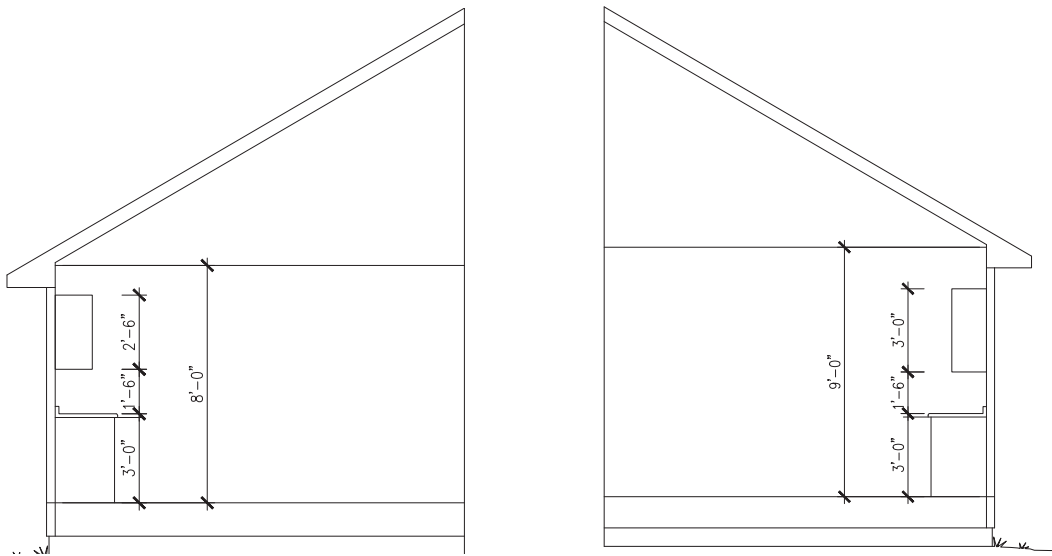

Our walls come in two different heights. 8' is our standard height, but you can upgrade to 9'. Upper cabinet heights change with the different wall heights.

PROW FRONT

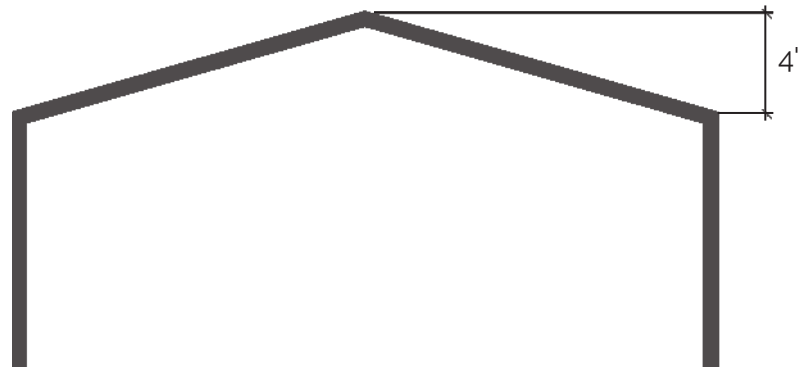
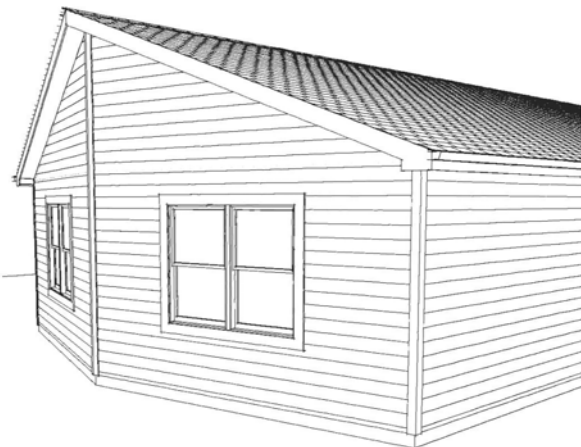

A prow front that sticks out 4' from one of the ends of your house can be added as an extra feature to give your house a unique architectural style. The 4' prow length is fixed and does not vary with the width of a house.

BUMPOUTS

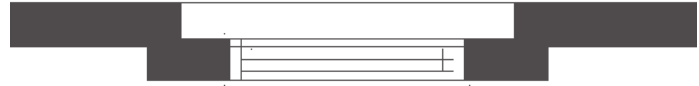
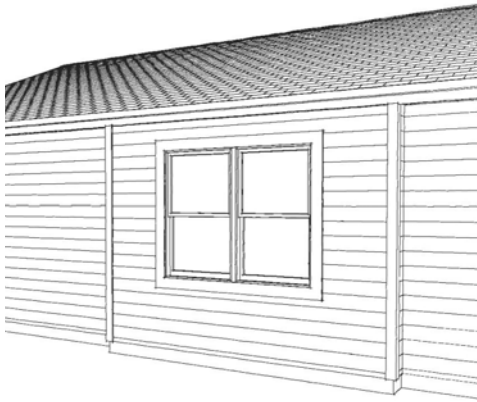

6" WINDOW BUMPOUT

- 6" deep
- Up to 20' long
- Great way to add curb appeal
- Can be tied into same size dormer above

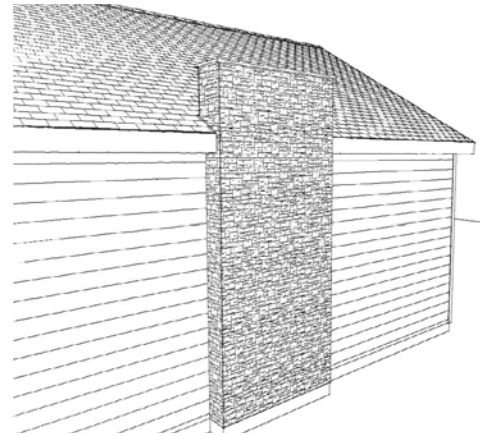
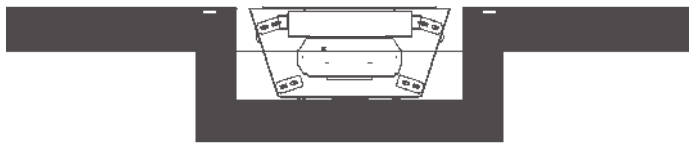

14" FIREPLACE BUMPOUT

- 14" deep
- Can be finished with Versetta Stone or siding
- Great way to add curb appeal

BAY WINDOWS

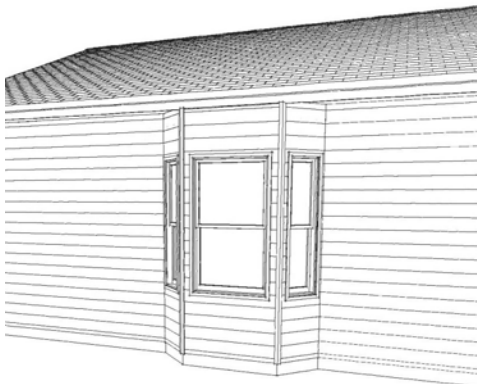

Bay windows are 16" deep with a 45 degree angle on the sides. The side windows are fixed 18" wide (DH1654), but the length of the center segment can be any size-minimum window width to meet egress is 3' by 5'-4" (DH3054).

ROOF PITCHES

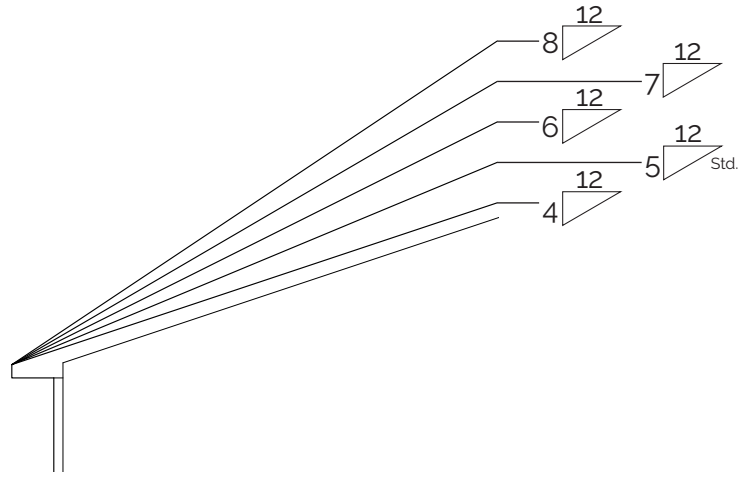

5/12 is our standard pitch for a roof, however you can upgrade to any pitch from 4/12 - 8/12.

FACTORY FINISHED VAULTED CEILINGS

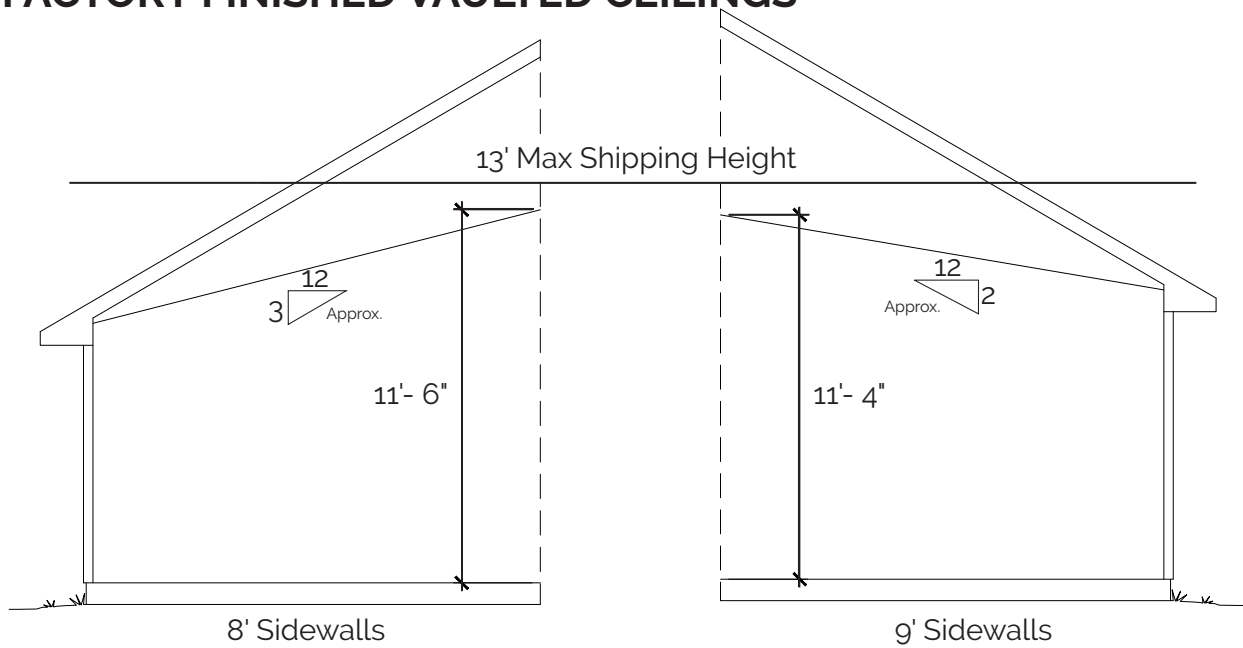

For a vaulted ceiling in a house with 8' walls, the ceiling will have a pitch of approx. 3/12, in a 9' wall house the pitch will be approx. 2/12. These pitches are not fixed to the pitch of the actual roof which can be customized to your liking. Trap windows on an end wall will follow the ceiling pitch and not the roof pitch. The pitch of the vault will be lower (less steep) with wider boxes due to the max shipping height of 13'.

TRAY CEILINGS

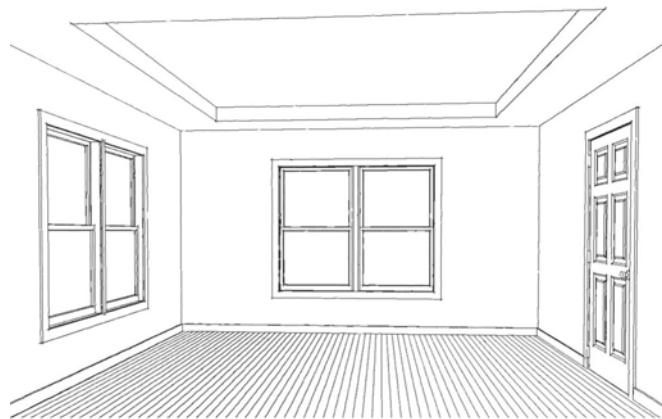

A section of ceiling can be raised up 6" to create a tray ceiling for added ceiling height.

- 6" depth
- 45 or 90 degree angle
- Double tray available (Limited to 22 1/2" wide)

CAPE ROOF PITCHES

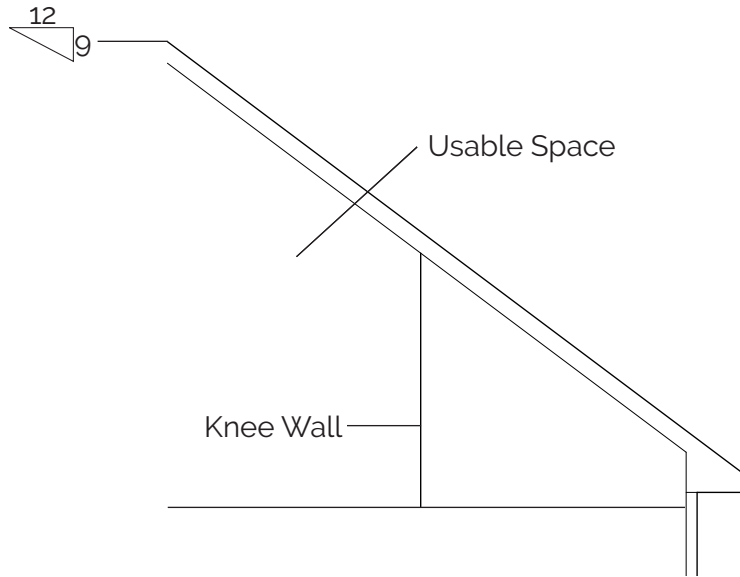

Cape roof pitches come with attic space that can either be finished or left unfinished. 9/12 is our cape roof pitch.

ATTIC SPACE-CAPE

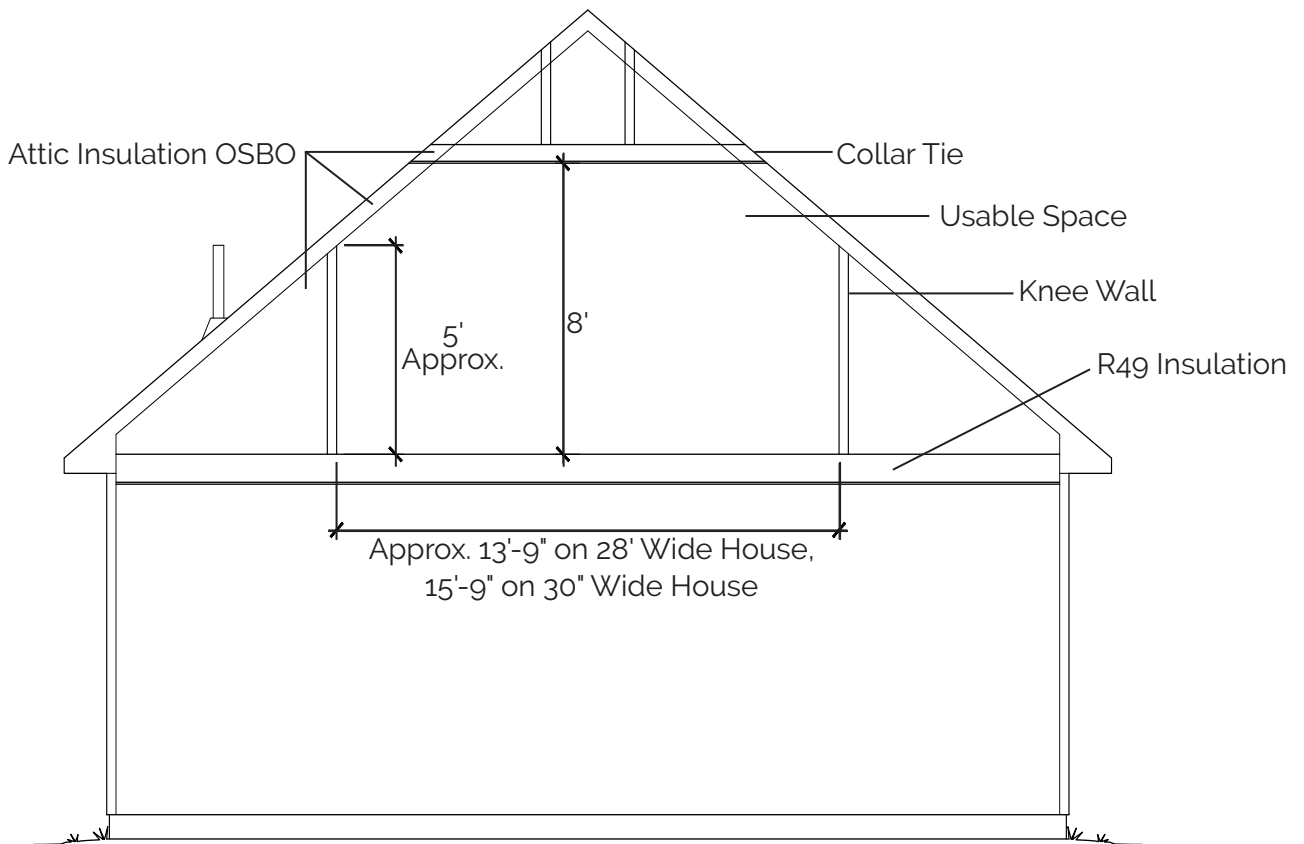

The attic space in a cape roof is defined by an approximately 5' knee wall on the sides and an 8' ceiling. The width of the usable space depends on the width of the house but is approximately 13'-9" on 28' wide house, and 15'-9" on 30' wide house.

REGULAR DORMERS

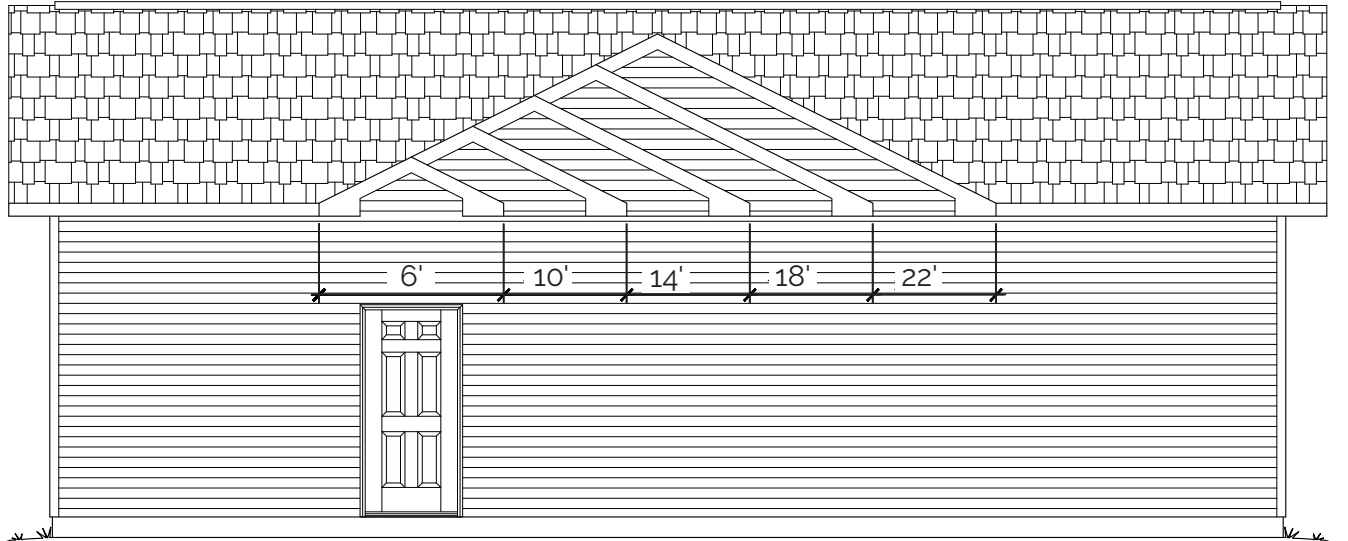

Regular dormers come in 6', 10', 14', 18' and 22' sizes. The double dormer effect can be achieved by choosing a smaller sized dormer to be placed inside a larger one.

OTHER AVAILABLE DORMERS

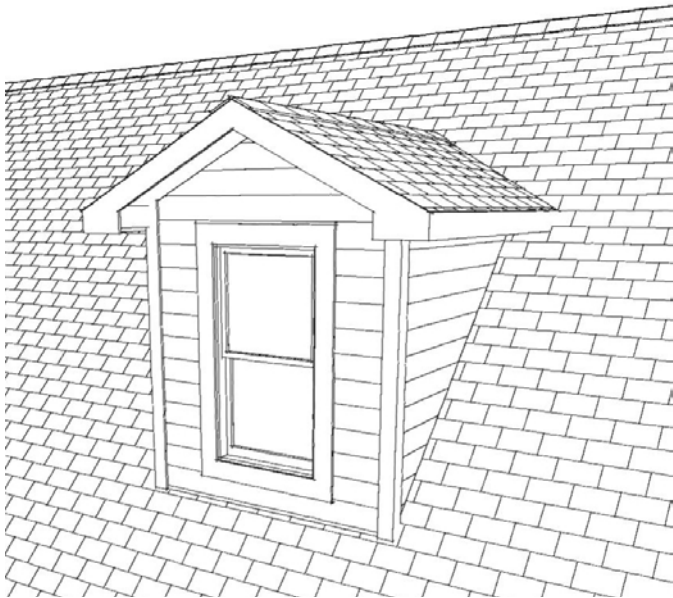

DOG HOUSE DORMER

- 5/12 or 6/12 roof pitch
- 6' or 9' wide
- 3056E window

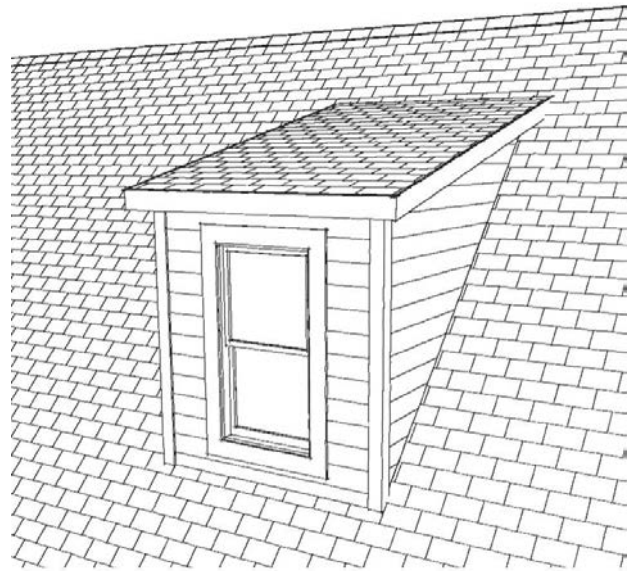

SHED DORMERS

- 3/12 roof pitch
- Customizable width
- Customizable window length

FACTORY FINISHED VAULTED DORMERS

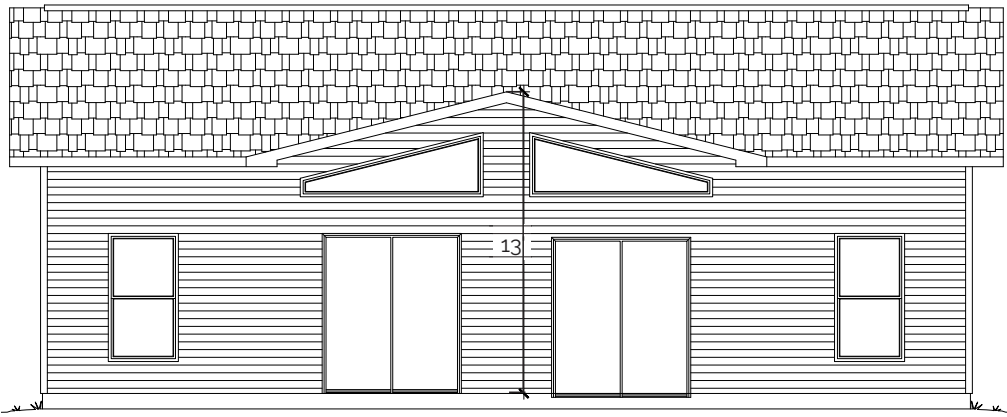

Vaulted dormers are a great way to add more height to your ceilings inside. Vaulted dormers, 13' high or under, can be completed in our factory. Due to max shipping height, anything over 13' high must be completed on-site.

ON-SITE FINISHED VAULTED DORMERS

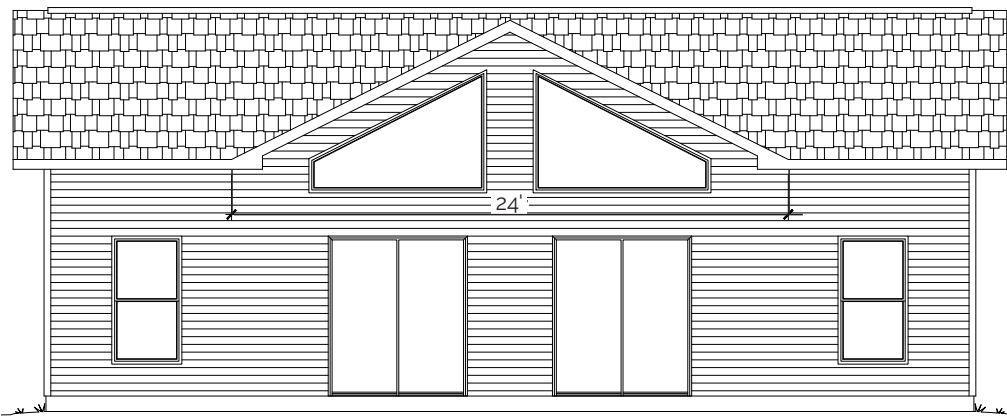

When you want even more ceiling height, on-site finished dormers are not limited to the 13' max shipping height that factory finished ones are. With a width of 24', these true vaults can be any height up to the height of the rest of your roof.

TOWER DORMERS

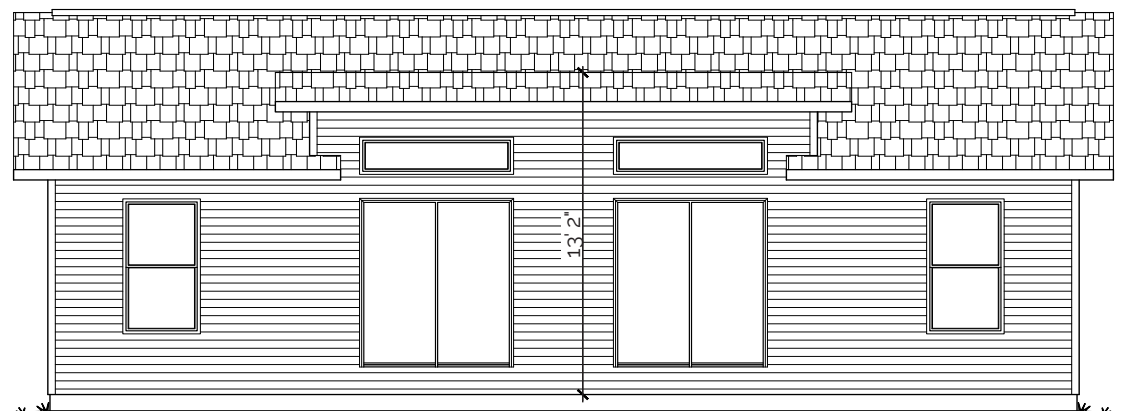

A tower dormer is a great way to add ceiling height in a factory finished option. A tower dormer is similar to a shed dormer in appearance, and can be combined with a tray ceiling for nearly 10' of ceiling height. Only available with 8' sidewalls

COVERED DECKS WITH RAILINGS

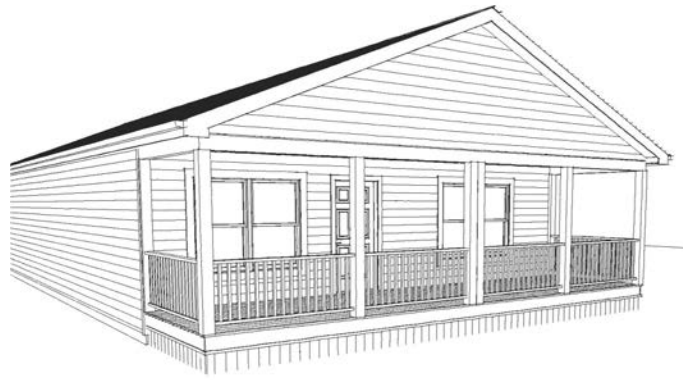

- Available in 6', 8', or 10' railings
- Max gap of 8" between posts
- Double post to center

UNCOVERED DECKS WITH RAILINGS



- Available in 6', 8', or 10' railings
- Max gap of 8" between posts

LEDGERBOARDS

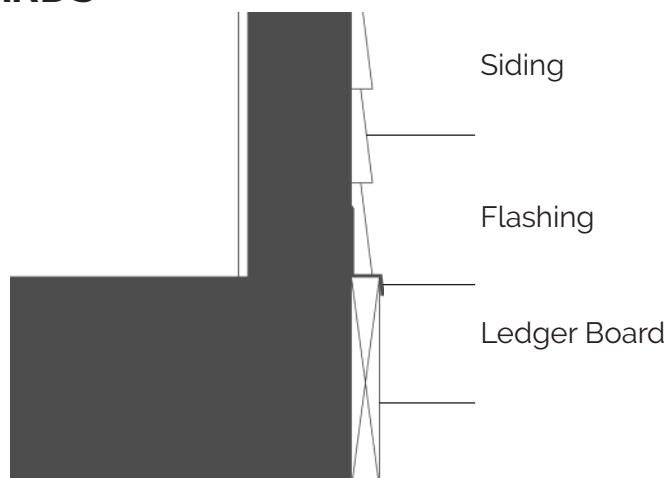

For decks that are being added onsite, we offer an upgrade option to add a ledgerboard complete with flashing ready for the installation of the deck.



CUSTOMER SATISFACTION

We are committed to keeping our customers happy and satisfied! If you have any questions about our warranty or service please contact our dedicated customer service team!



DOWNLOAD **WARRANTIES ONLINE**

Visit www.northstarsb.com/resources to download individual product warranties from the manufacturers.

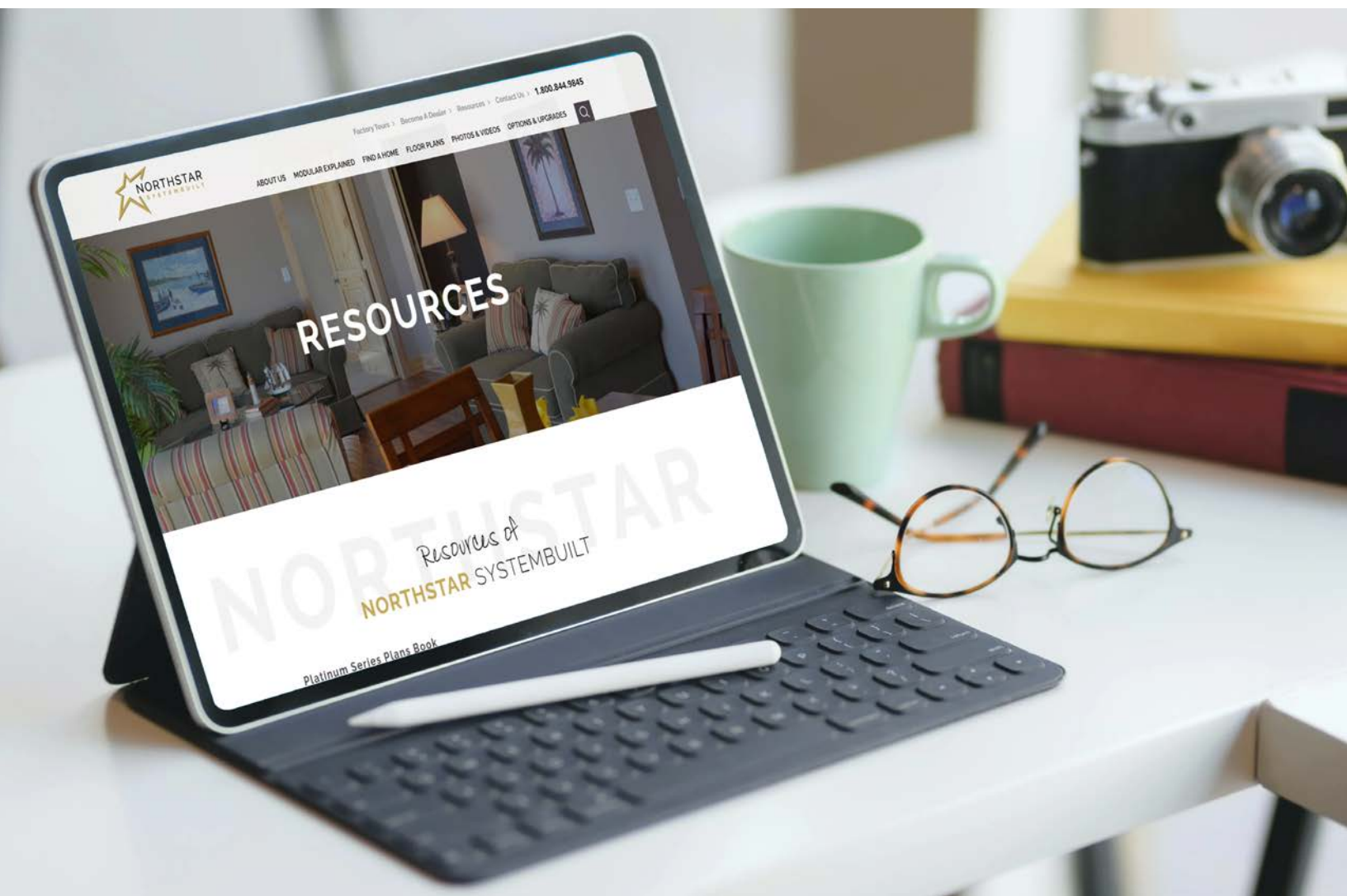

WARRANTY

PRODUCT WARRANTY

30 Day Cosmetic Warranty -Cosmetic Damage including but not limited to dings, dents, scratches, blemishes to interior and exterior of home including on any item within, installed, part of or on the home including but not limited to windows, doors, siding, trim, flooring, appliances, fixtures, MUST be reported within 30 days after delivery of the home to the site in order to be covered under this warranty. This warranty excludes cosmetic damage covered by original manufacturer's warranty as well as any slight color variation due to inherent differences in appearance, color or finish.

The customer is given specific legal rights that may vary from state to state. Each customer is encouraged to refer to his or her specific rights.

327A.02 STATUTORY WARRANTIES

Subdivision 1.Warranties by vendors.

In every sale of a completed dwelling, and in every contract for the sale of a dwelling to be completed, the vendor shall warrant to the vendee that:

- (a) during the one-year period from and after the warranty date the dwelling shall be free from defects caused by faulty workmanship and defective materials due to noncompliance with building standards;
- (b) during the two-year period from and after the warranty date, the dwelling shall be free from defects caused by faulty installation of plumbing, electrical, heating, and cooling systems due to noncompliance with building standards; and
- (c) during the ten-year period from and after the warranty date, the dwelling shall be free from major construction defects due to noncompliance with building standards.

For additional Subdivisions under this statute, please refer to Minnesota State Statute 327A

Each building fabricated at the listed facility (Section100.00) is warranted to the original purchaser for one year from date of retail delivery by the company. The company reserves the right of deciding the appropriate correction of any defect as per all applicable codes.

All construction methods comply with the applicable codes approved herein at the time of fabrication.

Repair, adjustment or replacement of any defective items manufactured at the plant facility, will be provided free of charge. Non-warranted items excluded.

CONDITIONS OF WARRANTY

All claims must be submitted in writing to their Dealer. Dealer must be allowed reasonable time to investigate claim. Claims must include; home owner's name, address, serial number, date of purchase, and full claim description.

All work to correct claim by dealer, must have the manufacturer's approval.

Items having their own warranties shall apply. Extensions of warranty will be made by the company as required by state laws. Such warranties will be included in shipping packet.

Dealer is solely responsible for any claims, or contracts they make.

EXCLUSIONS TO WARRANTY

- Quality, performance or durability of any finish or product outside of the list of options and upgrades that are offered in our sales materials in which the customer has selected for their home due to preference, for example. We will also not assist with facilitation of any claims with the original manufacturer or distributor of those finishes or products. The homeowner takes 100% responsibility for these products and finishes.
- Any wall or floor issues at the mating line of the modular pieces subject to or due to on-site work.
- Damaged exterior finishes caused by carelessness of on-site workers.
- Damages or losses due to shipping/transportation incidents/conditions (i.e. water damage, theft, etc.).
- Any damage caused by compromising the structural stability of the structure (i.e. cutting through the center rim joists).
- Any damage caused by inadequate ventilation system (i.e. not installing an air exchanger).
- Damage caused by altering factory-installed items or not compiling to any/all applicable building code items, either factory installed or on-site.
- Any damage or loss caused by theft, vandalism, or abnormal weather conditions including but not limited to; rain storms, flooding, hail, snow storms, fires, wind storms, tornadoes, or any act of God.

This serves as the entire warranty issued by the company. The company will not be held liable for any claims or damages outside this warranty, as per state laws.

Rev 19.09.26 (For most current revision visit www.northstarsb.com/resources to download a copy of the warranty)

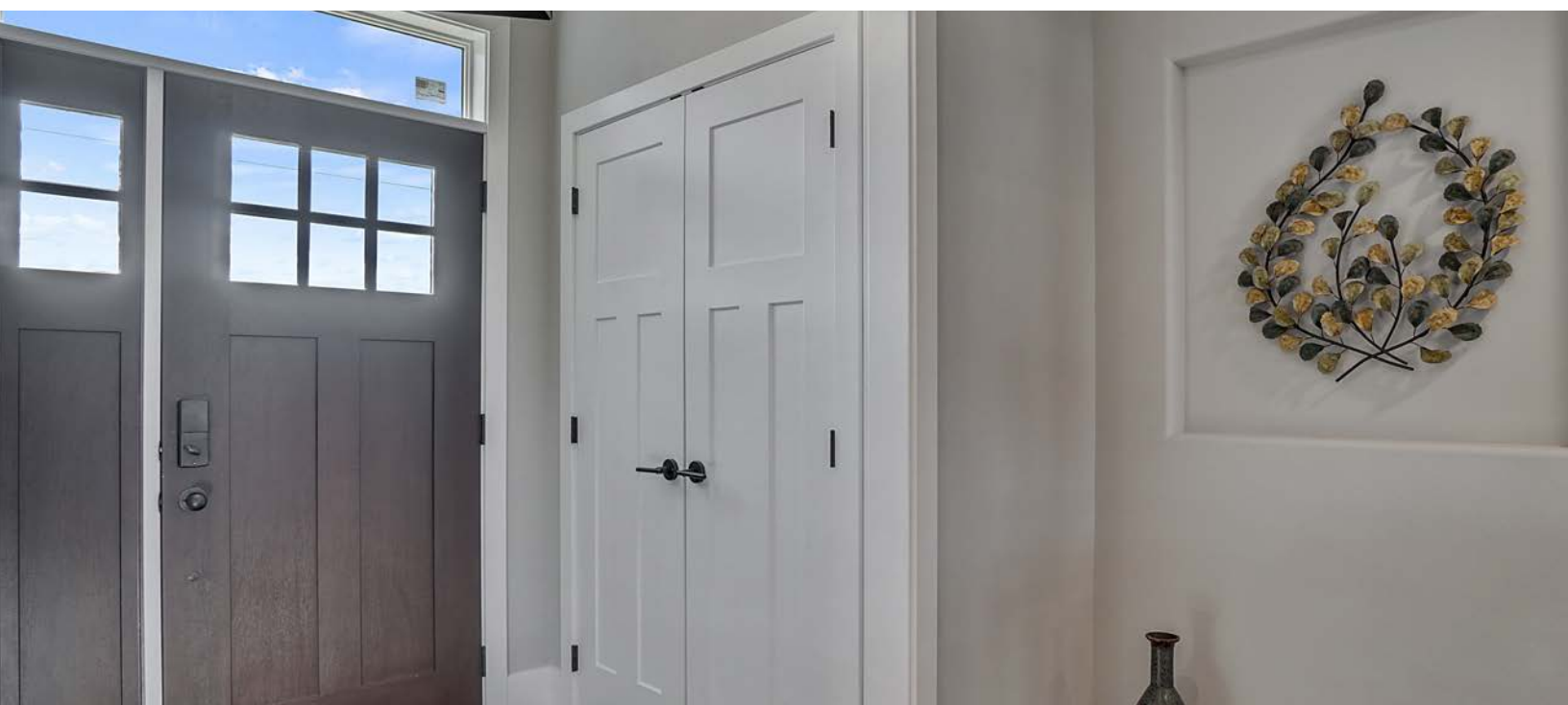

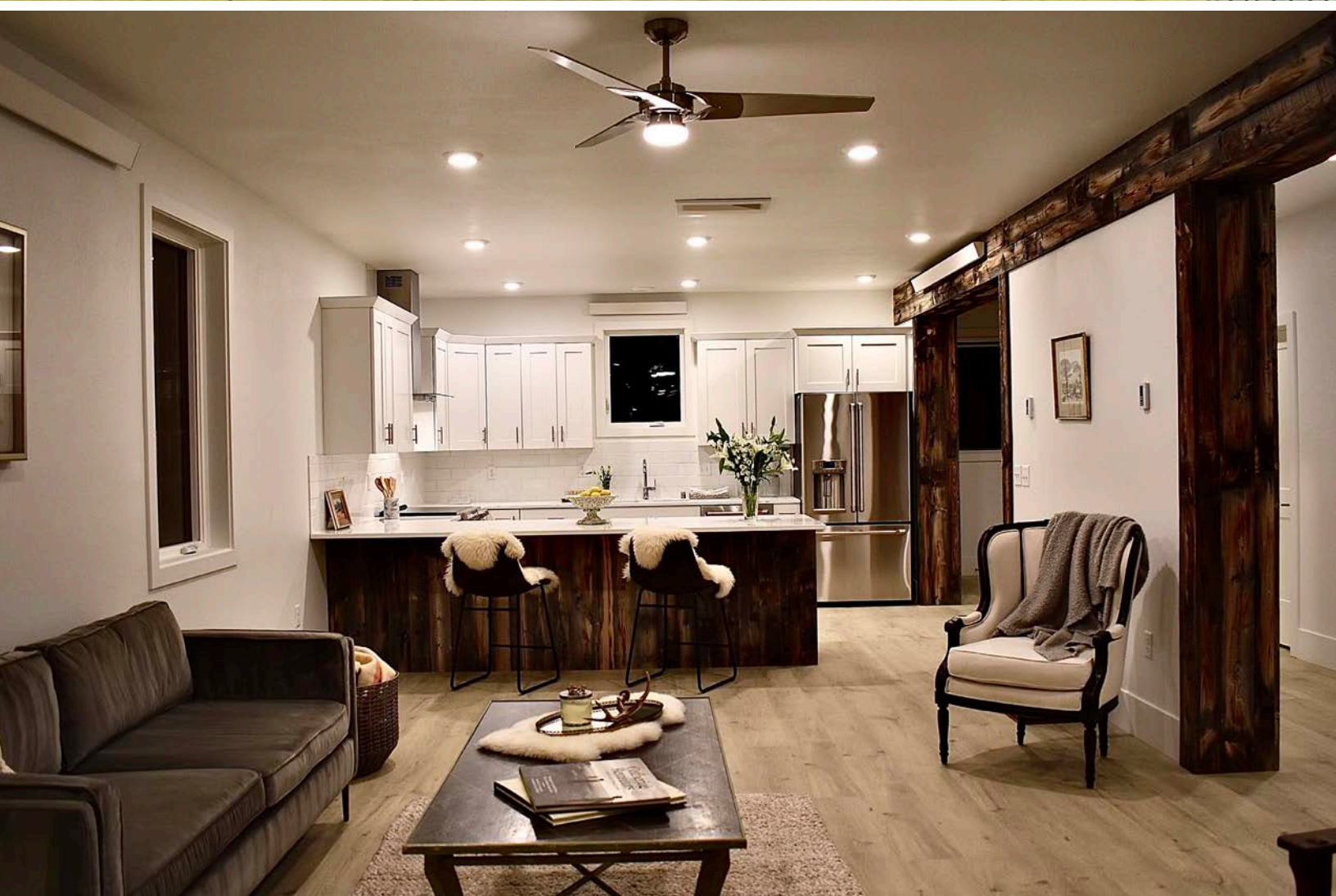



Corporate Office:
203 Industrial Drive
Redwood Falls, MN 56283

Watertown Office:
715 21st St SW
Watertown, SD 57201

www.northstarsb.com | 1.800.844.9845 | March 2024

